

JVC

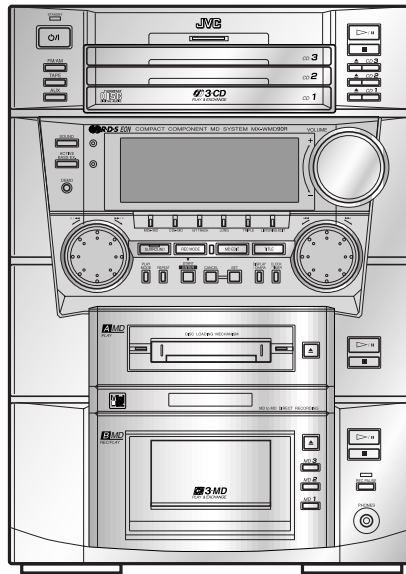

COMPACT COMPONENT MD SYSTEM

CA-WMD90R



 **R-D-S EON**



COMPACT
disc
DIGITAL AUDIO

INSTRUCTIONS

For Customer Use:

Enter below the Model No. and Serial No. which are located either on the rear, bottom or side of the cabinet. Retain this information for future reference.

Model No. _____

Serial No. _____

LVT0275-001A

[B]

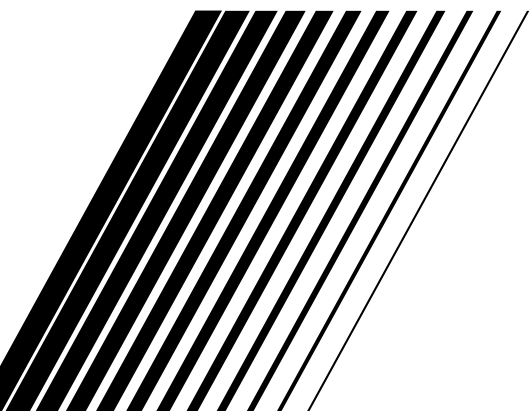

Warnings, Cautions and Others

IMPORTANT for the U.K.

DO NOT cut off the mains plug from this equipment. If the plug fitted is not suitable for the power points in your home or the cable is too short to reach a power point, then obtain an appropriate safety approved extension lead or consult your dealer.

BE SURE to replace the fuse only with an identical approved type, as originally fitted.

If nonetheless the mains plug is cut off ensure to remove the fuse and dispose of the plug immediately, to avoid a possible shock hazard by inadvertent connection to the mains supply.

If this product is not supplied fitted with a mains plug then follow the instructions given below:

IMPORTANT:

DO NOT make any connection to the terminal which is marked with the letter E or by the safety earth symbol or coloured green or green-and-yellow.

The wires in the mains lead on this product are coloured in accordance with the following code:

Blue : Neutral
Brown : Live

As these colours may not correspond with the coloured markings identifying the terminals in your plug proceed as follows:

The wire which is coloured blue must be connected to the terminal which is marked with the letter N or coloured black.

The wire which is coloured brown must be connected to the terminal which is marked with the letter L or coloured red.

IF IN DOUBT - CONSULT A COMPETENT ELECTRICIAN.

Caution — switch!

Disconnect the mains plug to shut the power off completely. The  switch in any position does not disconnect the mains line.

The power can be remote controlled.

CAUTION

To reduce the risk of electrical shocks, fire, etc.:

1. Do not remove screws, covers or cabinet.
2. Do not expose this appliance to rain or moisture.

REPRODUCTION OF LABELS

- ① CLASSIFICATION LABEL, PLACED ON REAR ENCLOSURE

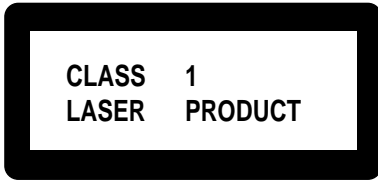

- ② WARNING LABEL, PLACED INSIDE THE UNIT

DANGER: Invisible laser radiation when open and interlock failed or defeated. AVOID DIRECT EXPOSURE TO BEAM. (e)	VARNING: Osynlig laserstrålning när denna del är öppnad och spärren är urkopplad. Betrakta ej strålen. (s)	ADVARSEL: Usynlig laserstrålning ved åbning, når sikkerhedsafbrydere er ude af funktion. Undgå udsættelse for stråling (d)	VARO: Avattaessa ja suo- jalukitus ohitettaessa olet alltiina näkymättömälle lasersäteilylle. Älä katso säteeseen. (f)
---	---	---	---

1. CLASS 1 LASER PRODUCT
2. **DANGER:** Invisible laser radiation when open and interlock failed or defeated. Avoid direct exposure to beam.
3. **CAUTION:** Do not open the top cover. There are no user serviceable parts inside the Unit; leave all servicing to qualified service personnel.

Caution: Proper Ventilation

To avoid risk of electric shock and fire, and to prevent damage, locate the apparatus as follows:

- 1 Front:
No obstructions and open spacing.
- 2 Sides/ Top/ Back:
No obstructions should be placed in the areas shown by the dimensions below.
- 3 Bottom:
Place on the level surface. Maintain an adequate air path for ventilation by placing on a stand with a height of 10 cm or more.

Front view

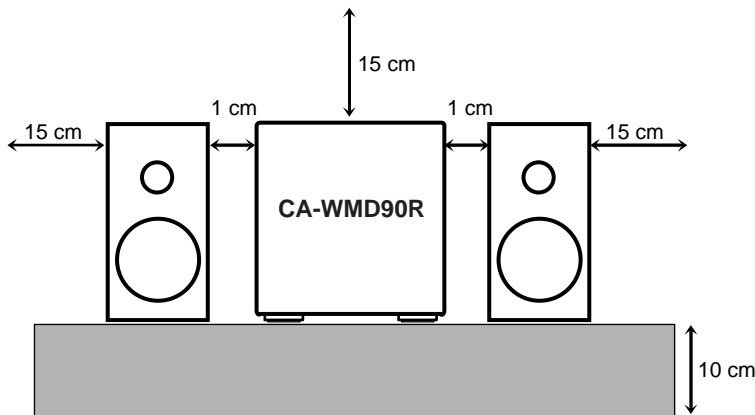

Side view

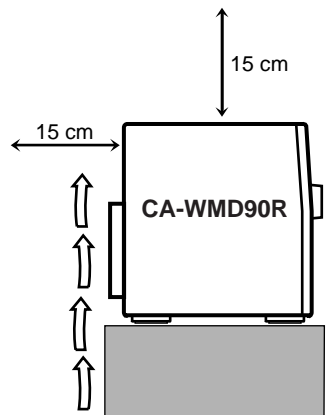

Introduction



We would like to thank you for purchasing one of our JVC products. Before operating this unit, read this manual carefully and thoroughly to obtain the best possible performance from your unit, and retain this manual for future reference.

About This Manual

This manual is organized as follows:

- The manual mainly explains operations using the buttons and controls on the unit. You can also use the buttons on the remote control if they have the same or similar names (or marks) as those on the unit. If operation using the remote control is different from that using the unit, it is then explained.
- Basic and common information that is the same for many functions is grouped in one place, and is not repeated in each procedure. For instance, we do not repeat the information about turning on/off the unit, setting the volume, changing the sound effects, and others, which are explained in the section “Basic and Common Operations” on pages 10 – 12.
- The following marks are used in this manual:



Gives you warnings and cautions to prevent from a damage or risk of fire/electric shock.

Also gives you information which is not good for obtaining the best possible performance from the unit.



Gives you information and hints you had better know.

Precautions

Installation

- Install in a place which is level, dry and neither too hot nor too cold — between 5°C (41°F) and 35°C (95°F).
- Install the unit in a location with adequate ventilation to prevent internal heat built-up in the unit.
- Leave sufficient distance between the unit and the TV.
- Keep the speakers away from the TV to avoid interference with TV.



DO NOT install the unit in a location near heat sources, or in a place subject to direct sunlight, excessive dust or vibration.

Power sources

- When unplugging from the wall outlet, always pull the plug, not the AC power cord.



DO NOT handle the AC power cord with wet hands.

Moisture condensation

Moisture may condense on the lens inside the unit in the following cases:

- After starting heating in the room
- In a damp room
- If the unit is brought directly from a cold to a warm place

Should this occur, the unit may malfunction. In this case, leave the unit turned on for a few hours until the moisture evaporates, unplug the AC power cord, and then plug it in again.

Others

- Should any metallic object or liquid fall into the unit, unplug the unit and consult your dealer before operating any further.
- If you are not going to operate the unit for an extended period of time, unplug the AC power cord from the wall outlet.



DO NOT disassemble the unit since there are no user serviceable parts inside.

If anything goes wrong, unplug the AC power cord and consult your dealer.

Contents



Location of the Buttons and Controls	3	Programming the Playing Order of the Tracks	
Front Panel	4	— Program Play	26
Remote Control	5	Playing at Random — Random Play	28
Getting Started	6	Repeating Tracks — Repeat Play	28
Unpacking	6	Recording on MDs	29
Putting the Batteries into the Remote Control	6	Before You Start Recording	30
Connecting Antennas	6	Recording FM/AM (MW/LW) Broadcasts or from	
Connecting Speakers	7	the Cassette Deck – Standard Recording	31
Connecting Other Equipment	8	Recording from the External (AUX) Equipment	
Basic and Common Operations	10	– AUX Recording	31
Setting the Clock	11	Various Recording Functions	32
Turning On the Power and Selecting the Sources ..	11	Synchronized Recording	32
Adjusting the Volume	11	First Track Recording	34
Reinforcing the Bass Sound	12	Listening Edit Recording	35
Activating the Surround Effect	12	Triple Recording	36
Selecting the Sound Modes	12	Long Recording	37
Creating Your Own Sound Mode		Editing MDs	38
— MANUAL Mode	12	Introducing MD Editing Functions	39
Listening to FM and AM (MW/LW)		DIVIDE Function	40
Broadcasts	13	JOIN Function	41
Tuning in a Station	14	MOVE Function	41
Presetting Stations	14	ERASE Function	42
Tuning in a Preset Station	15	ALL ERASE Function	43
Receiving FM Stations with RDS	15	Assigning Titles to MDs	44
Changing the RDS Information	15	Assigning a Title Using the Unit	45
Searching for Programs by PTY Codes		Assigning a Title Using the Remote Control	47
(PTY Search)	16	Using the Timers	49
Switching to a Program Type of Your Choice		Using Recording Timer	50
Temporarily	16	Using Daily Timer	51
Playing Back CDs	19	Using Sleep Timer	52
Loading CDs	20	Timer Priority	52
Playing Back the Entire Discs		Maintenance	53
— Continuous Play	20	Additional Information	54
Basic CD Operations	20	MD Disc Types	54
Programming the Playing Order of the Tracks		ATRAC (Adaptive TRansform Acoustic Coding) ..	54
— Program Play	21	UTOC (User Table Of Contents)	54
Playing at Random — Random Play	22	SCMS (Serial Copy Management System)	54
Repeating Tracks or CDs — Repeat Play	22	Sound Skip Guard Memory	55
Prohibiting Disc Ejection — Disc Lock	22	Troubleshooting	56
Playing Back MDs	23	MD Messages	57
Loading MDs	24	Specifications	58
Playing Back the Entire MD			
— Continuous Play	24		
Basic MD Operations	25		

Location of the Buttons and Controls

Become familiar with the buttons and controls on your unit.

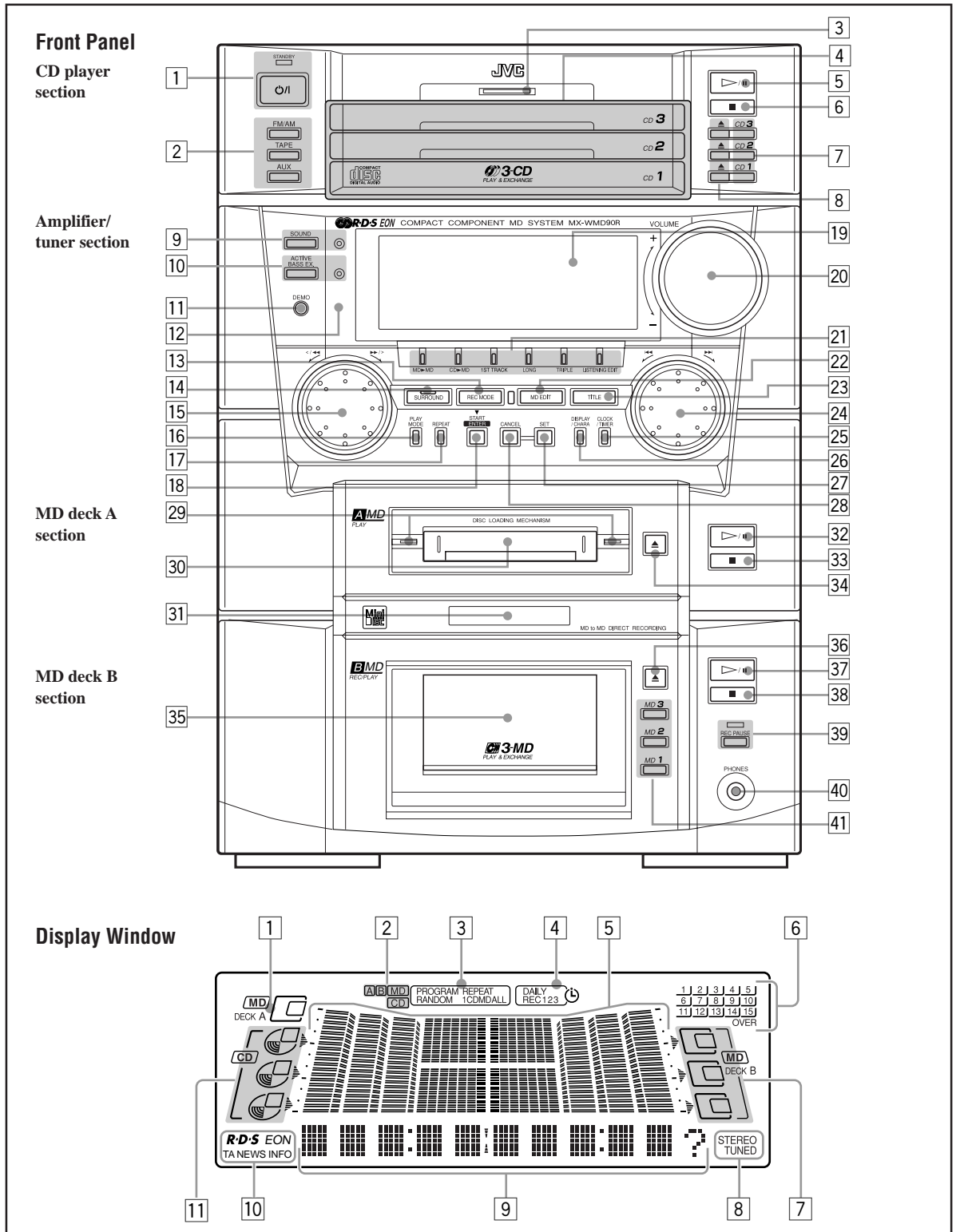

See pages in the parentheses for details.

Front Panel

Amplifier/tuner section

- 1 O/I (Standby/On) button and STANDBY lamp (11)
- 2 Source selecting buttons (11, 14, 31)
 - FM/AM, TAPE, and AUX buttons
 - Pressing one of these buttons also turns on the unit.*
- 3 CD operation lamp
 - *Lights when the CD is playing and flashes when pausing the play.*
- 4 CD trays (20)
- 5 CD $\triangleright / \text{II}$ (play/pause) button (20)
 - *Pressing this button also turns on the unit.*
- 6 CD \blacksquare (stop) button (20)
- 7 CD number buttons and lamps (20)
 - CD 1, CD 2, and CD 3
 - Pressing one of these buttons also turns on the unit.*
- 8 CD \blacktriangle (open/close) buttons (20)
 - *Pressing one of these buttons also turns on the unit.*
- 9 SOUND button and lamp (12)
- 10 ACTIVE BASS EX. (extension) button and lamp (12)
- 11 DEMO button (9)
- 12 Remote sensor
- 13 REC MODE button (32)
- 14 SURROUND button and lamp (12)
- 15 Left jog dial (\leftarrow / \rightarrow , $\blacktriangleleft / \blacktriangleright$)
- 16 PLAY MODE button (21, 22, 26 – 28)
- 17 REPEAT button (22, 28)
- 18 START button (33)
- ENTER button (40)
- 19 Display window
- 20 VOLUME control (11)
- 21 Recording mode lamps
 - MD \blacktriangleright MD, CD \blacktriangleright MD, 1ST TRACK, LONG, TRIPLE, and LISTENING EDIT
- 22 MD EDIT button (40)
- 23 TITLE button (45)
- 24 Right jog dial ($\blacktriangleleft / \blacktriangleright$)
- 25 CLOCK/TIMER button (11, 50)
- 26 DISPLAY/CHARA (character) button (25, 33, 45)
- 27 SET button
- 28 CANCEL button

MD deck A section

- 29 MD A operation lamps (24)
- 30 MD A loading slot
- 31 MD to MD direct recording indicator
 - *Lights when the unit is turned on and flashes while recording MD deck A onto MD deck B by using Various Recording Functions.*
- 32 MD A $\triangleright / \text{II}$ (play/pause) button (24)
 - *Pressing this button also turns on the unit.*

- 33 MD A \blacksquare (stop) button (24)
- 34 MD A \blacktriangle (eject) button (24)
 - *Pressing this button also turns on the unit.*

MD deck B section

- 35 MD B loading slot cover
- 36 MD B \blacktriangle (open/close) button (24)
 - *Pressing this button also turns on the unit.*
- 37 MD B $\triangleright / \text{II}$ (play/pause) button (24)
 - *Pressing this button also turns on the unit.*
- 38 MD B \blacksquare (stop) button (24)
- 39 REC PAUSE button and lamp (31)
- 40 PHONES jack (11)
- 41 MD number buttons and lamps (24)
 - MD 1, MD 2, and MD 3
 - Pressing one of these buttons also turns on the unit.*

Display window

- 1 MD deck A indicator
- 2 MD/CD current source indicator
 - MD A/B and CD indicators
- 3 MD/CD play mode indicators
 - PROGRAM, RANDOM, and REPEAT (1/CD/MD/ALL)
- 4 Timer mode indicators
 - D , DAILY (Daily Timer) and REC1/2/3 (Recording Timer)
- 5 Graphical display
- 6 Track number indicators
 - The OVER indicator lights up when there are more than 15 tracks recorded in the currently selected disc.
- 7 MD B disc number indicators
- 8 Tuner mode indicators
 - STEREO and TUNED
- 9 Main display
 - Shows the source name, track number, and other information.
- 10 RDS operation indicators
 - RDS, EON, and TA/NEWS/INFO
- 11 CD number indicators

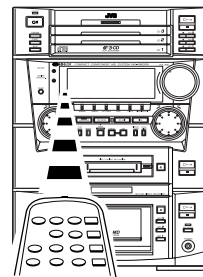

When using the remote control, point it at the remote sensor on the front panel.



Remote Control

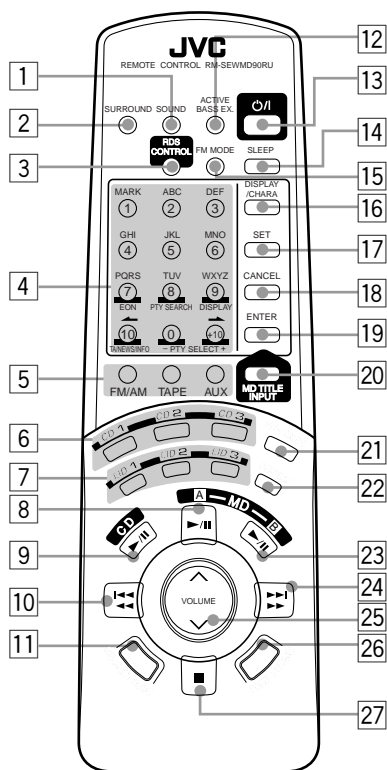

Remote Control

- 1 SOUND button (12)
- 2 SURROUND button (12)
- 3 RDS CONTROL button (15)
- 4 Number buttons *
 - 1 – 10, +10 buttons (14, 21, 25)
 - Character entry buttons (47)
 - ← / → buttons (47)
 - RDS operation buttons (15 – 17)
EON, PTY SEARCH, DISPLAY, TA/NEWS/INFO,
and PTY SELECT – / +
- 5 Source selecting buttons (11, 14)
 - FM/AM, TAPE, and AUX

Pressing one of these buttons also turns on the unit.
- 6 CD number buttons (20)
 - CD 1, CD 2, and CD 3

Pressing one of these buttons also turns on the unit.
- 7 MD number buttons (24)
 - MD 1, MD 2, and MD 3

Pressing one of these buttons also turns on the unit.
- 8 MD A ►/|| (play/pause) button (24)
 - Pressing this button also turns on the unit.
- 9 CD ►/|| (play/pause) button (20)
 - Pressing this button also turns on the unit.
- 10 ◀◀ / ◀ (reverse search/fast reverse) button * (21, 25)
- 11 MD REC PAUSE button (31)
- 12 ACTIVE BASS EX. (extension) button (12)
- 13 ⏻ (Standby/On) button (11)
- 14 SLEEP button (52)
- 15 FM MODE button (14)
- 16 DISPLAY/CHARA (character) button (25, 33, 47)
- 17 SET button
- 18 CANCEL button
- 19 ENTER button (40)
- 20 MD TITLE INPUT button (47)
- 21 PLAY MODE button (21, 22, 26 – 28)
- 22 REPEAT button (22, 28)
- 23 MD B ►/|| (play/pause) button (24)
 - Pressing this button also turns on the unit.
- 24 ►► / ► (forward search/fast forward) button * (21, 25)
- 25 VOLUME ^/∨ button (11)
- 26 FADE MUTING button (11)
- 27 ■ (stop) button * (20, 24)

* Before using these buttons (4, 10, 24, 27):

For tuner operations, press FM/AM on the remote control first when using the buttons (4).

For RDS operations, press RDS CONTROL on the remote control first when using the buttons (4).

For CD operations, press CD 1, CD 2, CD 3, or CD ►/|| on the remote control first when using the buttons (4, 10, 24, 27).

For MD operations, press MD 1, MD 2, MD 3, MD A ►/||, or MD B ►/|| on the remote control first when using the buttons (4, 10, 24, 27).

For entering MD titles, press MD TITLE INPUT on the remote control first when using the buttons (4).



To operate the unit correctly using the remote control

Make sure that the operation mode for the unit is the same for the remote control.

Unpacking

After unpacking, check to be sure that you have all the following items.
The number in the parentheses indicates the quantity of the pieces supplied.

- AM loop antenna (1)
- FM antenna (1)
- Remote control (1)
- Batteries (2)

If any is missing, consult your dealer immediately.

Putting the Batteries into the Remote Control

Insert the batteries — R6P(SUM-3)/AA(15F) — into the remote control, by matching the polarity (+ and -) on the batteries with the + and - markings on the battery compartment.

When the remote control can no longer operate the unit, replace both batteries at the same time.

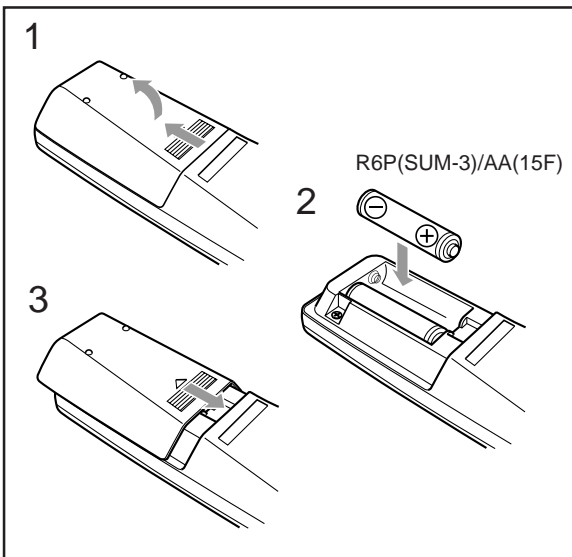

- DO NOT use an old battery together with a new one.
- DO NOT use different types of batteries together.
- DO NOT expose batteries to heat or flame.
- DO NOT leave the batteries in the battery compartment when you are not going to use the remote control for an extended period of time. Otherwise, it will be damaged from battery leakage.

Connecting Antennas

FM antenna

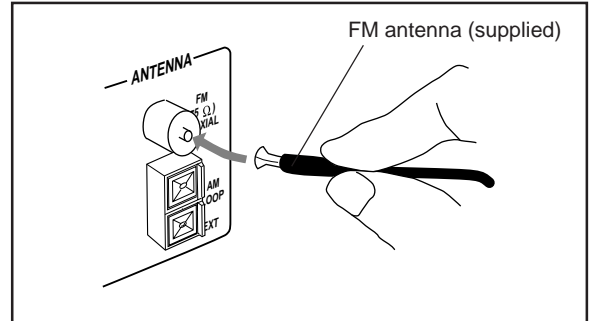

- 1 Attach the FM antenna to the FM (75 Ω) COAXIAL terminal.
- 2 Extend the FM antenna.
- 3 Fasten it up in the position which gives you the best reception.



About the supplied FM antenna

The FM antenna supplied with this unit can be used as temporary measure. If reception is poor, you can connect an outdoor FM antenna.

To connect an outdoor FM antenna

Before connecting it, disconnect the supplied FM antenna.

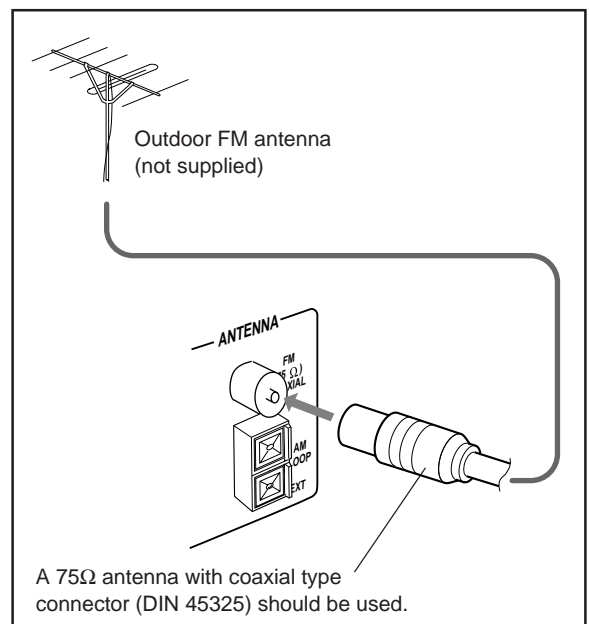

A 75Ω antenna with coaxial type connector (DIN 45325) should be used.

AM antenna

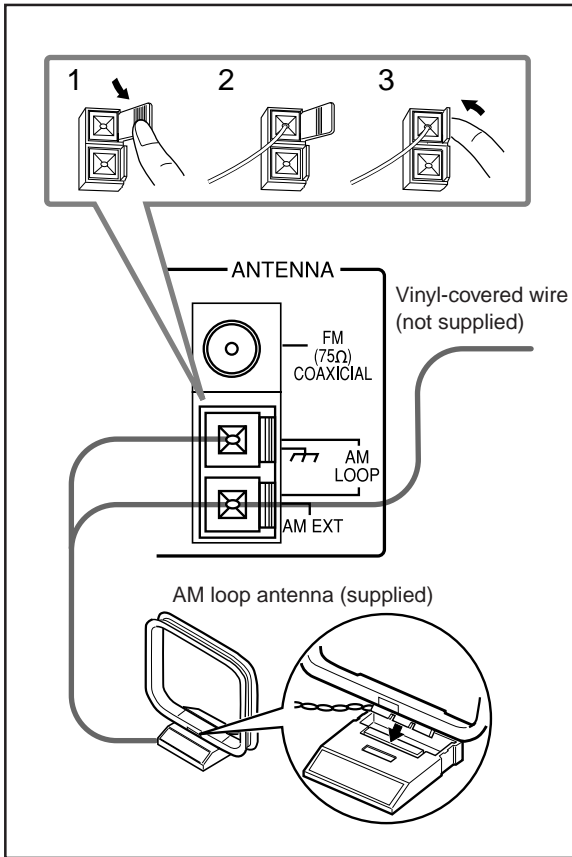

- 1 Connect the AM loop antenna to the AM LOOP terminals as illustrated.
- 2 Turn the AM loop antenna until you have the best reception.

To connect an outdoor AM antenna

When reception is poor, connect a single vinyl-covered wire to the AM EXT terminal and extend it horizontally. (The AM loop antenna must remain connected.)



For better reception of both FM and AM (MW/LW)

- Make sure the antenna conductors do not touch any other terminals and connecting cords.
- Keep the antennas away from metallic parts of the unit, connecting cords, and the AC power cord.

Connecting Speakers

You can connect the speakers using the speaker cords.

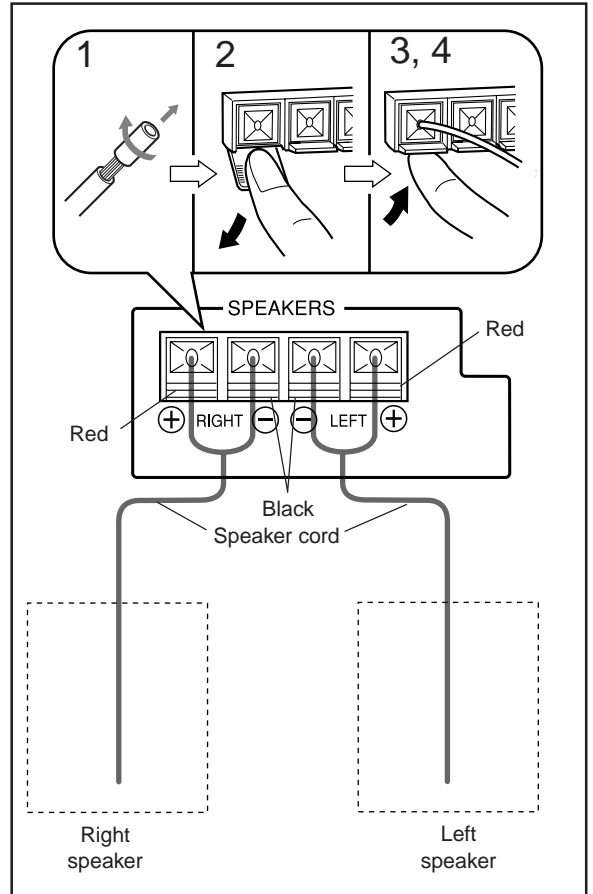

- 1 Twist the core of the cord at the end of each cord, then remove the insulation.
- 2 Open the speaker terminal.
- 3 Insert the end of the speaker cord to the terminal. Match the polarity of the speaker terminals: Red (+) to red (+) and black (-) to black (-).
- 4 Close the speaker terminal on the rear of the unit.

Use only speakers with the same speaker impedance as indicated by the speaker terminals on the rear of the unit.

Connecting Other Equipment

You can connect the following equipment to this unit:

- Cassette deck — used as a playback and recording device. By using the cassette deck, you can record any source played back on this unit.
- Audio equipment — used only as an analog playback device.
- Audio equipment with an optical digital output terminal — used only as a digital playback device.

When you connect and use these equipment, refer also to the manuals supplied with them.

Be sure that the plugs of the audio cords and the jacks on the rear of the unit are color coded: White plugs and jacks are for left audio signals, and red ones for right audio signals.



- DO NOT connect other equipment while the power is on.
- DO NOT plug in any equipment until all connections are complete.

To connect a cassette deck

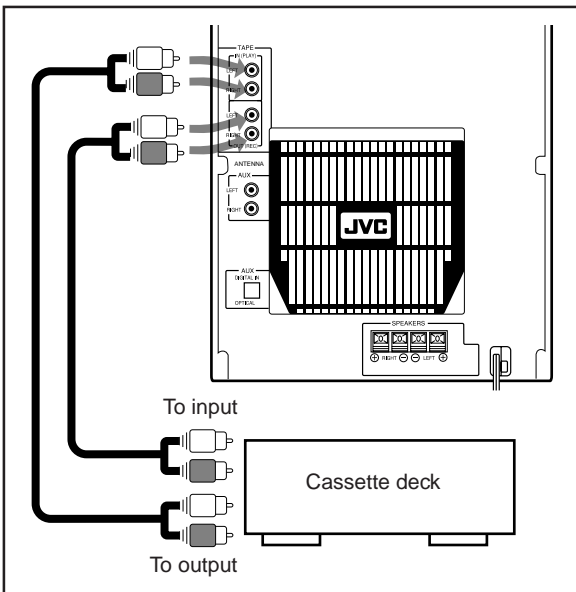

To connect audio equipment without a digital output terminal

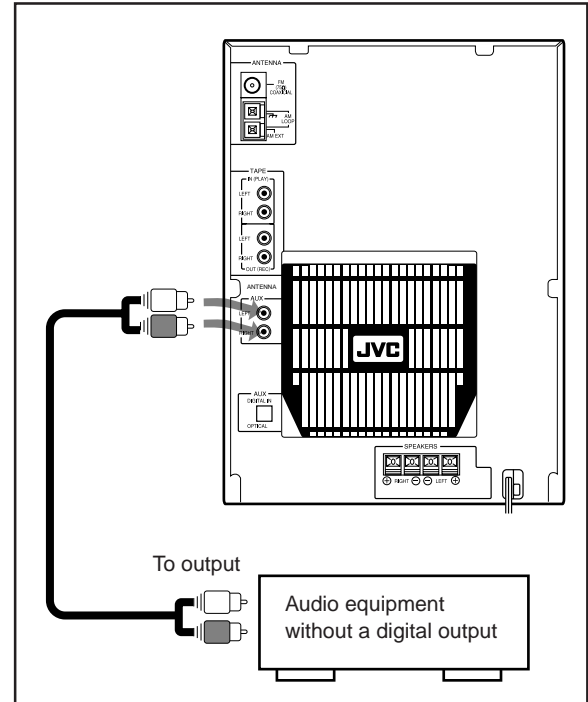

Connect the audio output jacks on the other equipment and the AUX jacks, using an audio cord (not supplied).

By using audio cords (not supplied), connect:

- Between the audio input jacks on the cassette deck and the TAPE OUT (REC) jacks — For recording on the cassette deck.
- Between the audio output jacks on the cassette deck and the TAPE IN (PLAY) jacks — For playing a tape.

Basic and Common Operations

Continued 

The buttons and controls enlarged in the illustration below are used and explained in this section (pages 11 to 12).

Front panel

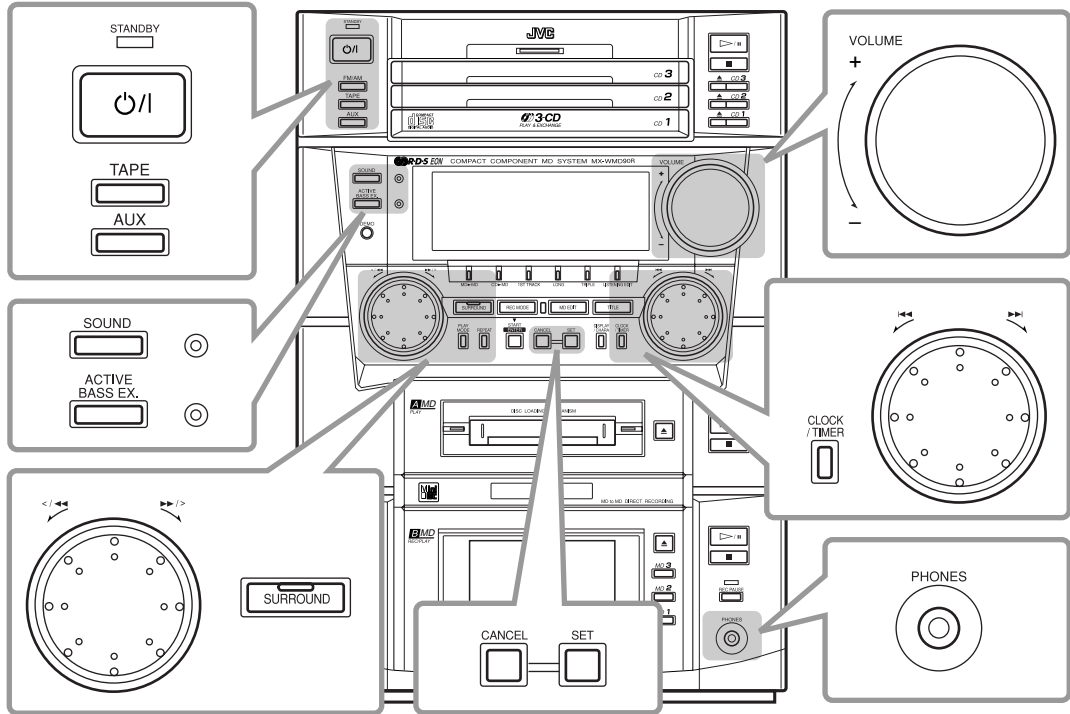

Remote control

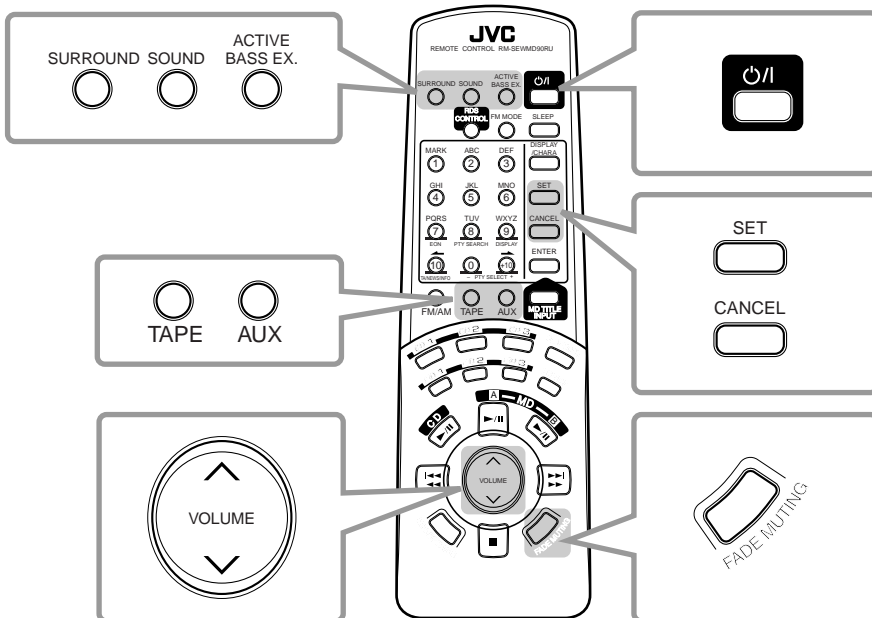

Here are basic and common things that apply to all the functions of the unit.

Setting the Clock

You can set the clock whether the unit is turned on or in standby mode.

On the unit ONLY:

1 Press CLOCK/TIMER.

The hour digit in the main display starts flashing.

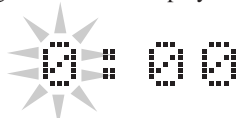

2 Rotate the right jog dial to adjust the hour, then press SET.

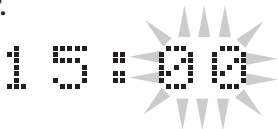

- If you want to correct the hour after pressing SET, press CANCEL. The hour digit starts flashing again.

3 Rotate the right jog dial to adjust the minute, then press SET.

To adjust the clock again

Once you have adjusted the clock, you need to press CLOCK/TIMER nine times until the clock setting mode is selected (the hour digit starts flashing).



If there is a power failure

The clock loses the setting and is reset to "0:00." You need to set the clock again.

Turning On the Power and Selecting the Sources

When you press the play button (▷/||) for a particular source, the unit automatically turns on (and starts playing the source).

To select the external equipment as the source, press TAPE or AUX so that the unit automatically turns on.

To turn on the unit without playing, press ⏻ so that the STANDBY lamp goes off.

To turn off the unit (on standby), press ⏻ again so that the STANDBY lamp lights red.

A little power is always consumed even while the unit is in standby mode.

To switch off the power supply completely, unplug the AC power cord from the AC outlet.



When you unplug the AC power cord or if a power failure occurs

The clock is reset to "0:00" right away, while the tuner preset stations and other settings will be erased in a few days.

Adjusting the Volume

You can adjust the volume level only while the unit is turned on.

Turn VOLUME clockwise to increase the volume or counterclockwise to decrease it.

When using the remote control, press VOLUME ▲ to increase the volume or press VOLUME ▼ to decrease it.



For private listening

Connect a pair of headphones to the PHONES jack. No sound comes out of the speakers. Be sure to turn down the volume before connecting or putting on the headphones.



DO NOT turn off (on standby) the unit with the volume set to an extremely high level; otherwise, the sudden blast of sound can damage your hearing, speakers and/or headphones when you turn on the unit or start playing any source.

REMEMBER you cannot adjust the volume level while the unit is in standby mode.

To turn down the volume level temporarily

Press FADE MUTING on the remote control.

To restore the sound, press the button again.



Reinforcing the Bass Sound

The richness and fullness of the bass sound is maintained regardless of how low you set the volume. You can use this effect only for playback.

To get the effect, press ACTIVE BASS EX. (extension) so that the ACTIVE BASS EX. lamp lights up on the unit.

ACT-BASS

(in the main display)

To cancel the effect, press the button again so that the lamp goes off. "OFF" also appears in the main display.

Activating the Surround Effect

You can obtain a "being-there" feeling while listening to any source.

You can use this effect only for playback.

To get the effect, press SURROUND so that the SURROUND lamp lights up on the unit.

- Each time you press the button, the surround effect changes as follows:

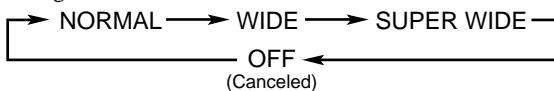

The surround effect increases as you select —:

NORMAL → WIDE → SUPER WIDE

To cancel the effect, press the button repeatedly until the SURROUND lamp goes off. "OFF" also appears in the main display.

Selecting the Sound Modes

You can select one of the 5 preset sound modes.

You can use the sound mode only for playback.

To select the sound modes, press SOUND repeatedly so that the SOUND lamp lights up on the unit.

- Each time you press the button, the sound modes change as follows:

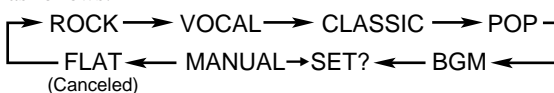

ROCK: Good for rock'n'roll.

VOCAL: Good for vocal music.

CLASSIC: Good for classical music.

POP: Enhances middle frequency.

BGM: Good for easy-listening.

MANUAL → SET?: Your individual mode stored in memory. See "Creating Your Own Sound Mode — MANUAL Mode."

FLAT: Cancels the sound mode.

Creating Your Own Sound Mode — MANUAL Mode

You can create and store your own sound mode only by using the buttons and controls on the unit.

- There is a time limit in doing the following steps. If the setting is canceled before you finish, start from step 1 again.

On the unit ONLY:

- 1** Press SOUND repeatedly until "MANUAL → SET?" appears in the main display.

MANUAL → SET?

- 2** Press SET.

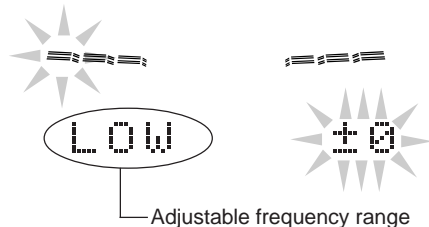

- 3** Adjust the equalizer pattern.

- 1) Rotate the left jog dial to select the frequency range to adjust (LOW, MIDDLE, HIGH).**
- 2) Rotate the right jog dial to adjust the level (-3 to +3) of the selected frequency range.**

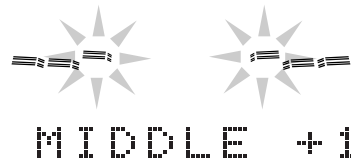

- 3) Repeat steps 1) and 2) to adjust the level of the other frequency ranges.**

- 4** Press SET again (or wait until the above indication disappears).

The equalizer pattern you have created is stored in memory.

To use your own sound mode

Select "MANUAL → SET?" when using the sound modes. See "Selecting the Sound Modes."

Listening to FM and AM (MW/LW) Broadcasts

The buttons and controls enlarged in the illustration below are used and explained in this section (pages 14 to 18).

Front panel

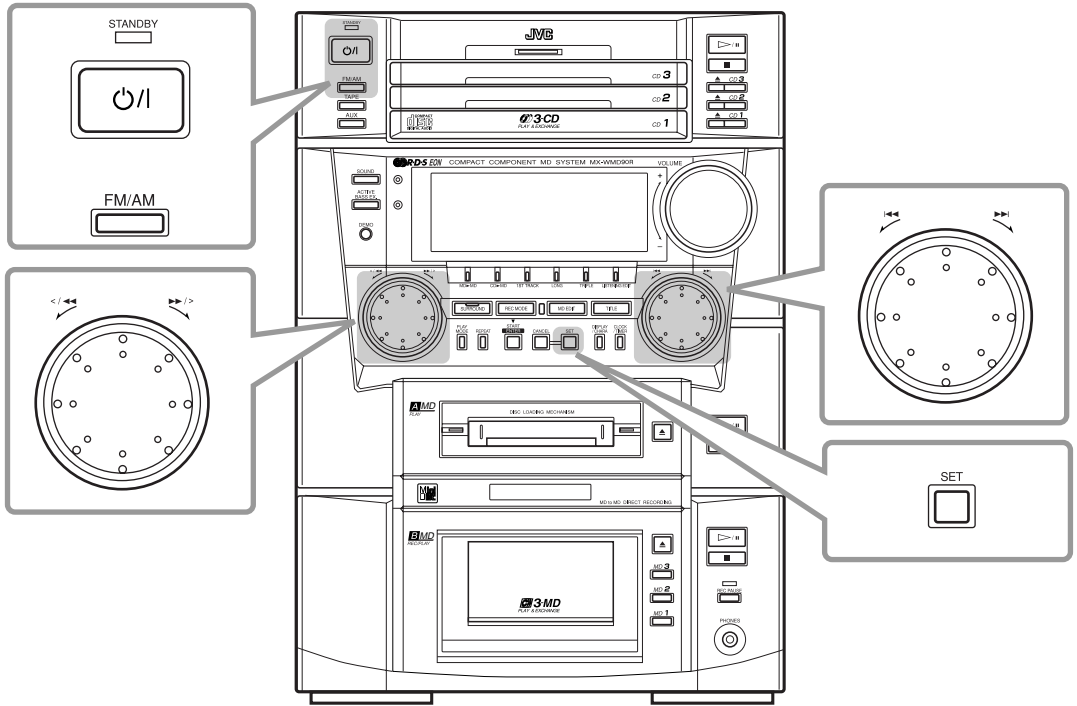

Remote control

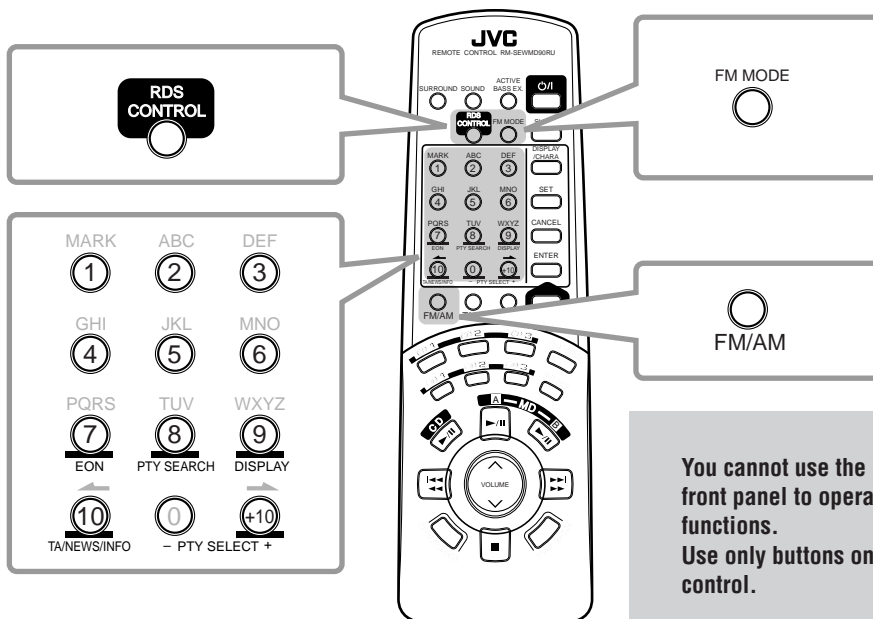

You cannot use the buttons on the front panel to operate the RDS functions. Use only buttons on the remote control.

When using the number buttons on the remote control, make sure that they are ready for tuner operations.

- Pressing FM/AM on the remote control makes the number buttons ready for tuner operations.

Tuning in a Station

On the unit ONLY:

1 Press FM/AM.

The unit automatically turns on and tunes in the previously tuned station (either FM or AM–MW/LW).

- Each time you press the button, the band alternates between FM and AM.

2 Rotate the *left* jog dial quickly until the station frequencies change in the main display.

- Clockwise: to increase the frequencies.
- Counterclockwise: to decrease the frequencies.

The unit starts searching stations and stops when a station of sufficient signal strength is tuned in (the TUNED indicator lights).

If a program is broadcast in stereo, the STEREO indicator also lights.

To stop during searching, rotate the *left* jog dial briefly again.



When you rotate the *left* jog dial slowly

The frequency changes step by step.

To change the FM reception mode

When an FM stereo broadcast is hard to receive or noisy, press FM MODE on the remote control so that “MONO” appears in the main display. Reception improves.

To restore the stereo effect, press FM MODE again so that “AUTO” appears in the main display.

In this stereo mode, you can hear stereo sounds when a program is broadcast in stereo.

Presetting Stations

You can preset 30 FM and 15 AM (MW/LW) stations at random.

In some cases, test frequencies have been already memorized for the tuner since the factory examined the tuner preset function before shipment. This is not a malfunction. You can preset the stations you want into memory by following the presetting method.

- There is a time limit in doing the following steps. If the setting is canceled before you finish, start from step 1 again.

On the unit ONLY:

1 Tune in the station you want to preset.

- See “Tuning in a Station” to the left.

FM 87.50

2 Press SET.

The current preset number starts flashing.

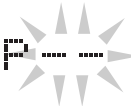
FM **P** 

3 Rotate the *right* jog dial to select a preset number.

- Clockwise: to increase the preset numbers.
- Counterclockwise: to decrease the preset numbers.

4 Press SET again.

The tuned station in step 1 is stored in the preset number selected in step 3.

MEMORY

- Storing a new station on a used number erases the previously stored one.



When you unplug the AC power cord or if a power failure occurs

The preset stations will be erased in a few days. If this happens, preset the stations again.

Tuning in a Preset Station

1 Press FM/AM.

The unit automatically turns on and tunes in the previously tuned station (either FM or AM–MW/LW).

- Each time you press the button, the band alternates between FM and AM (MW/LW).

2 Select a preset number.

On the unit:

Rotate the *right jog dial*.

- Clockwise: to increase the preset numbers.
- Counterclockwise: to decrease the preset numbers.

On the remote control:

Press the number buttons.

- Make sure that you have pressed FM/AM on the remote control before pressing the number buttons.
For preset number 5, press 5.
For preset number 15, press +10, then 5.
For preset number 20, press +10, then 10.

Receiving FM Stations with RDS

RDS allows FM stations to send an additional signal along with their regular program signals. For example, the stations send their station names, as well as information about what type of program they broadcast, such as sports or music, etc.

When tuned to an FM station which provides the RDS service, the RDS indicator lights up on the display.

With the unit, you can receive the following types of RDS signals.

PS (Program Service):

Shows commonly known station names.

PTY (Program Type):

Shows types of broadcast programs.

RT (Radio Text):

Shows text messages the station sends.

EON (Enhanced Other Networks):

Provides the information about the types of the programs sent by other RDS stations than the one being received.



More about RDS

- Not all FM stations provide RDS signals, nor do all RDS stations provide the same services. If in doubt, check with local radio stations for details on RDS in your area.
- RDS may not work correctly if the received station is not transmitting the signals properly or if the signal strength is weak.

Changing the RDS Information

You can see RDS information on the display while listening to an FM station.

- RDS operations are possible only using the remote control.

1 Press RDS CONTROL while listening to an FM station.

2 Press DISPLAY.

- Each time you press the button, the display changes to show the following information:

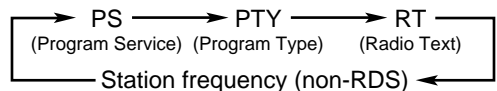

If No PS, PTY, or RT signals are sent by a station “no PS,” “no PTY” or “no RT” appears in the main display.



If the unit takes time to show the RDS information received from a station “wait PS,” “wait PTY,” or “wait RT” may appear on the display.

Searching for Programs by PTY Codes (PTY Search)

One of the advantages of RDS is that you can locate a particular kind of program by specifying the PTY codes.

- The PTY Search is applicable only to preset stations.
- There is a time limit in doing the following steps. If the setting is canceled before you finish, start from step 1 again.

To search for a program using the PTY codes, use the remote control:

- 1 Press RDS CONTROL while listening to an FM station.**
- 2 Press PTY SEARCH.**
“PTY SELECT” flashes in the main display.
- 3 Press PTY SELECT – / + to select a PTY code while “PTY SELECT” is flashing.**
Each time you press the button, the PTY codes change as follows (refer also to the list on page 18):

NONE ⇄ NEWS ⇄ AFFAIRS ⇄ INFO ⇄
 SPORT ⇄ EDUCATE ⇄ DRAMA ⇄ CULTURE ⇄
 SCIENCE ⇄ VARIED ⇄ POP M ⇄ ROCK M ⇄
 M.O.R. M ⇄ LIGHT M ⇄ CLASSICS ⇄
 OTHER M ⇄ WEATHER ⇄ FINANCE ⇄
 CHILDREN ⇄ SOCIAL A ⇄ RELIGION ⇄
 PHONE IN ⇄ TRAVEL ⇄ LEISURE ⇄ JAZZ ⇄
 COUNTRY ⇄ NATIONAL ⇄ OLDIES ⇄
 FOLK M ⇄ DOCUMENT ⇄ TEST ⇄
 ALARM ⇄ (back to the beginning)
- 4 Press PTY SEARCH again.**
While searching, “SEARCH” and the selected PTY code alternate on the display.
The unit searches 30 preset FM stations, stops when it finds the one you have selected, and tunes in that station.

To continue searching after the first stop:

Press PTY SEARCH again while the indications on the display are flashing.

If no program is found, “NOT FOUND” appears on the display and the unit returns to the last received station.

To stop searching any time during the process:

Press PTY SEARCH while searching.

Switching to a Program Type of Your Choice Temporarily

The EON function allows the unit to switch temporarily to a broadcast program of your choice (TA, NEWS, and/or INFO) from a different station except when you are listening to a non-RDS stations – some FM stations and AM (MW/LW) stations.

- The EON indicator lights while receiving a station with the EON code.
- EON function is applicable only to preset stations.

To activate the EON function, use the remote control:

- 1 Press RDS CONTROL while listening to an FM station.**
- 2 Press EON.**
The last EON data type selected — TA/NEWS/INFO — lights on the display window.
- 3 Press TA/NEWS/INFO repeatedly until the EON data type you want is selected.**
Each time you press the button, the EON data types change as follows:

TA → NEWS → INFO → TA NEWS →
 NEWS INFO → TA INFO → TA NEWS INFO →
 (back to the beginning)

TA: Traffic announcement
NEWS: News
INFO: Program the purpose of which is to impart advice in the widest sense.

To cancel the EON function, press EON again so that the TA/NEWS/INFO indicator goes off.

- If you cancel the EON function while receiving a program selected by the EON function, the unit goes back to the previously tuned station.

How the EON function actually works:

CASE 1

If there is no station broadcasting the program you have selected

The unit continues tuning in the current station.



When a station starts broadcasting the program you have selected, the unit automatically switches to the station. The indicator of received PTY code starts flashing.



When the program is over, “EON END” appears in the main display, and the unit goes back to the previously tuned station, but the EON function still remains activated.

CASE 2

If there is a station broadcasting the program you have selected

The unit tunes in the program. The indicator of received PTY code starts flashing.



When the program is over, “EON END” appears in the main display, and the unit goes back to the previously tuned station, but the EON function still remains activated.

CASE 3

If the FM station you are listening to is broadcasting the program you have selected

The unit continues to receive the station but the indicator of received PTY code starts flashing.



When the program is over, the indicator of received PTY code stops flashing and remains lit, but the EON function still remains activated.

Alarm function

If an ALARM (Emergency) signal is received from a station while listening to the radio, the unit automatically switches to the station broadcasting the ALARM signal, except when you are listening to non-RDS stations (all AM – MW/LW and some FM stations).

Test function

The TEST signal is used for testing the ALARM signal. Therefore, it makes the unit work in the same way as the ALARM signal does.

If a TEST signal is received from a station while listening to the radio, the unit automatically switches to the station broadcasting the TEST signal, except when you are listening to non-RDS stations (all AM – MW/LW and some FM stations).



More about the EON function

- EON data sent from some stations may not be compatible with this unit.
- While listening to a program tuned in by the EON function, the station does not change even if another network station starts broadcasting a program of the same EON data.
- While listening to a program tuned in by the EON function, you can only use the EON and DISPLAY buttons as the tuner operation buttons.
- If the stations alternate intermittently between the station tuned by the EON function and the currently tuned station (“WAITING” flashes in the main display), press EON to cancel the EON function.

If you do not press the button, the currently tuned station is received finally (“NOT FOUND” appears this time), and the indication of the EON data type flashing on the display disappears.



Description of the PTY codes:

NONE:	Undefined.	FINANCE:	Stock Market reports, commerce, trading etc.
NEWS:	News.	CHILDREN:	Programs targeted at a young audience.
AFFAIRS:	Topical program expanding or enlarging upon the news — debate, or analysis.	SOCIAL A:	Programs about sociology, history, geography, psychology and society.
INFO:	Program the purpose of which is to impart advice in the widest sense.	RELIGION:	Religious programs.
SPORT:	Program concerned with any aspect of sports.	PHONE IN:	Involving members of the public expressing their views either by phone or at a public forum.
EDUCATE:	Educational programs.	TRAVEL:	Travel information.
DRAMA:	All radio plays and serials.	LEISURE:	Programs about recreational activities.
CULTURE:	Programs concerning any aspect of national or regional culture, including language, theatre, etc.	JAZZ:	Jazz music.
SCIENCE:	Programs about natural sciences and technology.	COUNTRY:	Songs which originate from, or continue the musical tradition of the American Southern States.
VARIED:	Used for mainly speech-based programs like quizzes, panel games and personality interviews.	NATIONAL:	Current popular music of the nation or region in that country's language.
POP M:	Commercial music of current popular appeal.	OLDIES:	Music from the so-called "golden age" of popular music.
ROCK M:	Rock music.	FOLK M:	Music which has its roots in the musical culture of a particular nation.
M.O.R. M:	Current contemporary music considered to be "easy-listening."	DOCUMENT:	Program concerning factual matters, presented in an investigative style.
LIGHT M:	Instrumental music, and vocal or choral works.	TEST:	Broadcast for testing emergency broadcast equipment or receiver.
CLASSICS:	Performances of major orchestral works, symphonies, chamber music, etc.	ALARM:	Emergency announcement.
OTHER M:	Music not fitting into any of the other categories.	Classification of the PTY codes for some FM stations may be different from the above list.	
WEATHER:	Weather reports and forecasts.		

Playing Back CDs

The buttons and controls enlarged in the illustration below are used and explained in this section (pages 20 to 22).

Front panel

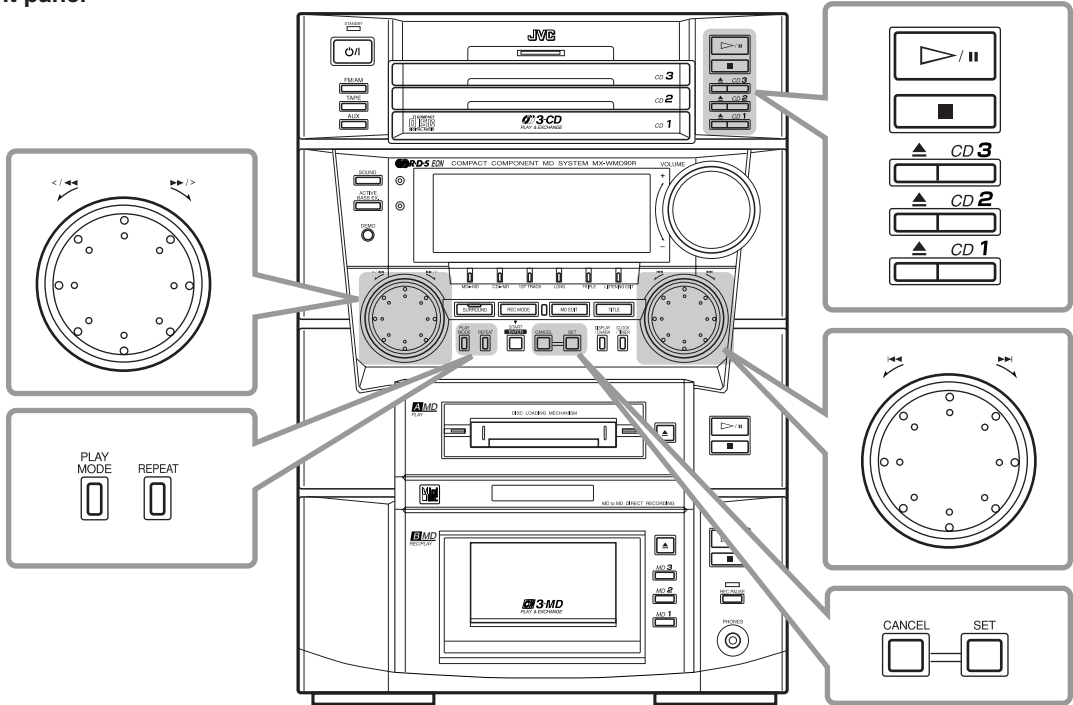

Remote control

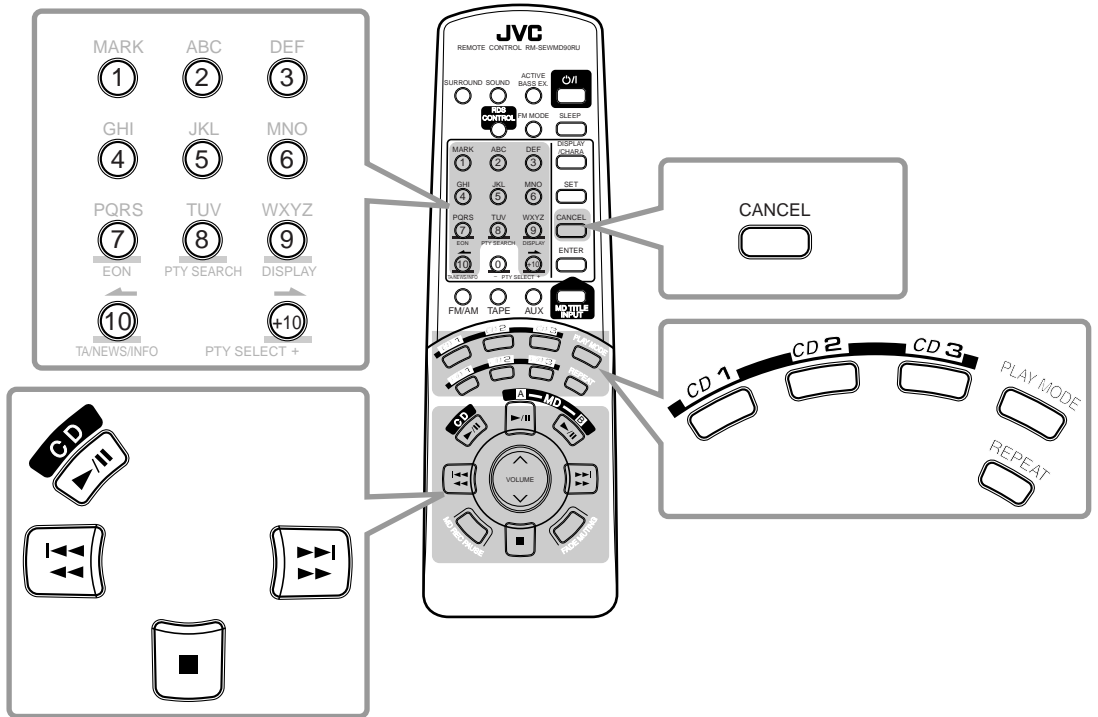

When using the remote control, make sure that it is ready for CD operations.

- Pressing CD 1, CD 2, CD 3, or CD ►/|| on the remote control makes the remote control ready for CD operations.

Loading CDs

1 Press one of the open/close buttons (▲) for the disc tray (CD 1 to CD 3) you want to load a CD onto. The unit automatically turns on and the selected disc tray comes out. The corresponding CD number lamp (CD 1 to CD 3) lights.

2 Place a disc correctly on the circle of the disc tray, with its label side up.

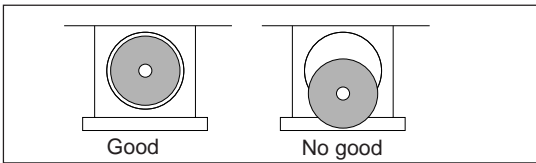
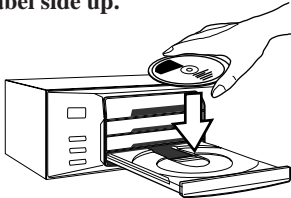

- When using a CD single (8 cm), place it on the inner circle of the disc tray.

3 Press the same open/close button (▲) you have pressed in step 1. The disc tray closes.

4 Repeat steps 1 to 3 to place other CDs.



When loading more than one CD continuously

Press the open/close button (▲) for the next tray you want to place a CD onto. The first disc tray automatically closes and the next disc tray comes out.



About the CD number lamps (CD 1 to CD 3 buttons)

Each disc number lamp corresponds to the disc tray of the same number.

- It lights green when you press ▲ and when the unit has recognized that there is a CD on the corresponding disc tray.
- It goes off when the unit has recognized that there is no CD on the corresponding disc tray.
- It flashes while a CD on the corresponding disc tray is played back or paused.

Playing Back the Entire Discs — Continuous Play

You can play CDs continuously.

1 Load CDs.

2 Press one of the CD number buttons (CD 1, CD 2 and CD 3) for the disc you want to play.

CD playback starts from the first track of the selected disc.

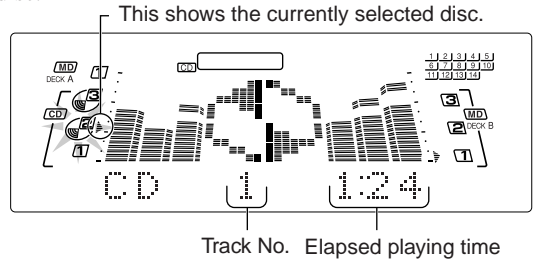

- Pressing ► / || for the CD player (or CD ►/|| on the remote control) instead of the CD number buttons starts playing back the currently selected CD.

To stop during play, press ■ for the CD player.

To remove the disc, press the corresponding open/close buttons (▲).



CD playback sequence

When 3 CDs are loaded on the disc trays, they are played in one of the following sequences.

- When CD 1 is pressed : CD 1 ⇒ CD 2 ⇒ CD 3 (then stops)
- When CD 2 is pressed : CD 2 ⇒ CD 3 ⇒ CD 1 (then stops)
- When CD 3 is pressed : CD 3 ⇒ CD 1 ⇒ CD 2 (then stops)
- * If no CD is on the disc trays, CD player skips that tray.

Basic CD Operations

While playing a CD, you can do the following operations.

To exchange CDs during playback of another

Press the open/close button (▲) corresponding to a CD number not currently being played to eject that disc tray and exchange the CD.

If CDs are exchanged during playback, playback will stop after playing all newly inserted CDs.

To stop playback for a moment

Press ► / || for the CD player (or CD ►/|| on the remote control).

To resume play, press ► / || for the CD player (or CD ►/|| on the remote control) again.

To locate a particular point in a track during play

On the unit:

Rotate the *left* jog dial.

- Counterclockwise (◀◀): Fast reverses the tacks.
- Clockwise (▶▶): Fast forwards the tracks.

On the remote control:

Press and hold ◀◀◀◀ or ▶▶▶▶.

- ◀◀: Fast reverses the tracks.
- ▶▶: Fast forwards the tracks.

To go to another track

On the unit:

Rotate the *right* jog dial.

- Counterclockwise (◀◀): Goes back to the beginning of the current or previous tracks.
- Clockwise (▶▶): Skips to the beginning of the next or succeeding tracks.

On the remote control:

Press ◀◀◀◀ or ▶▶▶▶ repeatedly.

- ◀◀: Goes back to the beginning of the current or previous tracks.
- ▶▶: Skips to the beginning of the next or succeeding tracks.

To go to another track directly using the number buttons

Pressing the number button(s) allows you to start playing the track number you want.

- Ex.: For track number 5, press 5.
For track number 15, press +10, then 5.
For track number 20, press +10, then 10.
For track number 32, press +10, +10, +10, then 2.

Programming the Playing Order of the Tracks — Program Play

You can arrange the order in which the tracks play before you start playing. You can program up to 32 tracks.

1 Load CDs.

- If the current playing source is not the CD player, press ▷ / || on the CD player (or CD ▶/|| on the remote control), then ■ on the CD player (or ■ on the remote control) before going to the next step.

2 Press PLAY MODE so that “CD PROGRAM” appears in the main display.

- Each time you press the button, play mode changes as follows:

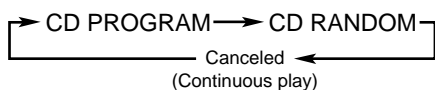

3 Press one of the CD number buttons (CD 1, CD 2, and CD 3) to select the CD number you want to play.

Ex. Disc No. 2 is selected

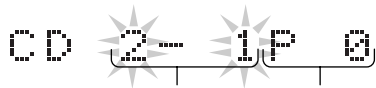

Disc No. and Track No. Step No.

4 Select the track from the CD selected in the above step.

On the unit:

Rotate the *right* jog dial to select the track number, then press SET.

On the remote control:

Press the number buttons.

- For how to use the number buttons, see “To go to another track directly using the number buttons” to the left.

Ex. Track No. 8 is selected



5 Program other tracks you want.

- To program tracks from the same disc, repeat step 4.
- To program tracks from a different disc, repeat steps 3 and 4.

6 Press ▷ / || on the CD player (or CD ▶/|| on the remote control).

The tracks are played in the order you have programmed.

To stop during play, press ■ on the CD player.

To exit from program play mode, press PLAY MODE once or twice, before or after play, so that the unit enters another playback mode (Random play or Continuous play mode).

To check the program contents

Before playing, you can check the program contents by pressing ◀◀◀◀ or ▶▶▶▶ on the remote control.

- ▶▶▶▶: Shows the programmed tracks in the programmed order.
- ◀◀◀◀: Shows them in the reverse order.

To modify the program

Before playing, you can erase the last programmed track by pressing CANCEL. Each time you press the button, the last programmed track is erased from the program.

- When you eject a disc, the tracks selected from that ejected disc are erased from the program.

To add tracks in the program before you start play, simply select track numbers you want to add.



If you try to program a 33rd step “CD FULL” will appear in the main display.



If your entry is ignored You have tried to program a track from an empty tray, or a track number that does not exist on the CD (for example, selecting track 14 on a CD that only has 12 tracks). Such entries are ignored.

Playing at Random — Random Play

The tracks of all loaded CDs will play at random.

1 Load CDs.

- If the current playing source is not the CD player, press ▷ / || on the CD player (or CD ▶/|| on the remote control), then ■ on the CD player (or ■ on the remote control) before going to the next step.

2 Press PLAY MODE repeatedly until “CD RANDOM” appears in the main display.

- Each time you press the button, play mode changes as follows:

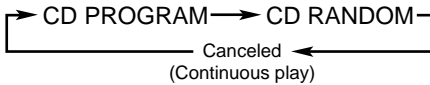

3 Press ▷ / || on the CD player (or CD ▶/|| on the remote control).

The tracks are played at random. Random play stops when all the tracks are played once.

To skip the playing track, rotate the right jog dial clockwise or press ►►|►► on the remote control.

- You cannot go back to the previous tracks by rotating the right jog dial counterclockwise or pressing |◀◀ ◀◀ on the remote control.

To stop during play, press ■ on the CD player. Random play also stops when you open a disc tray.

To exit from Random play mode, press PLAY MODE once or twice, before or after play, so that the unit enters another playback mode (Continuous play or Program play mode).

Repeating Tracks or CDs — Repeat Play

You can have all the CDs, the program or the individual track currently playing repeat as many times as you like.

To repeat play, press REPEAT during or before playing. Each time you press the button, Repeat play mode changes, and the REPEAT indicator changes to light as follows:

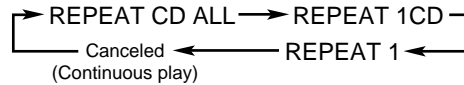

REPEAT CD ALL: Repeats all the tracks on all the CDs (continuously or at random), or all the tracks in the program.

REPEAT 1CD*: Repeats all the tracks on one CD.

REPEAT 1: Repeats one track on one CD.

- * REPEAT 1CD is not used for Program play and Random play.

To cancel Repeat play, press REPEAT repeatedly until no REPEAT indicator lights on the display.

- REPEAT 1CD is also canceled when you press PLAY MODE to change the play mode.

Prohibiting Disc Ejection — Disc Lock

You can prohibit CD and MD ejection from the unit and can lock discs.

On the unit ONLY:

To prohibit disc ejection, press ▲ for the CD 1 tray while holding ■ for the CD player with the unit set in standby mode.

“LOCKED” appears for a while, and the loaded discs (both CDs and MDs) are locked.

LOCKED



If you try to eject the locked discs “LOCKED” appears to inform you that the Disc Lock is in use.

To cancel the prohibition and unlock the discs, press ▲ for the CD 1 tray while holding ■ for the CD player with the unit set in standby mode.

“UNLOCKED” appears for a while, and the loaded discs (both CDs and MDs) are unlocked.

UNLOCKED

Playing Back MDs

The buttons and controls enlarged in the illustration below are used and explained in this section (pages 24 to 28).

Front panel

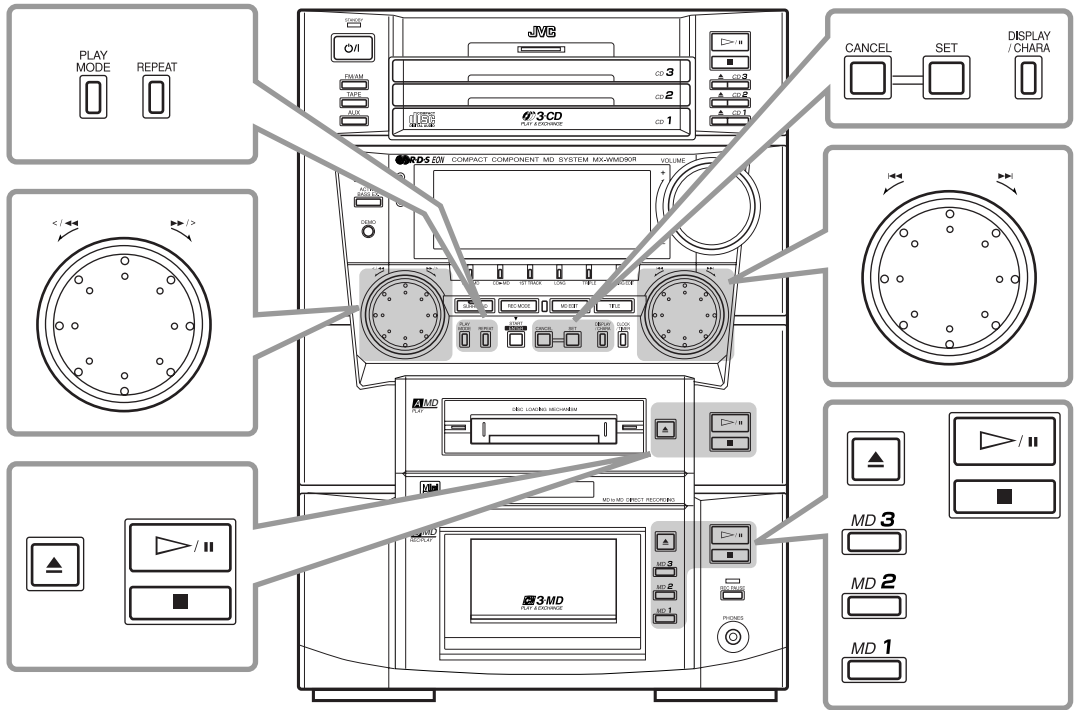

Remote control

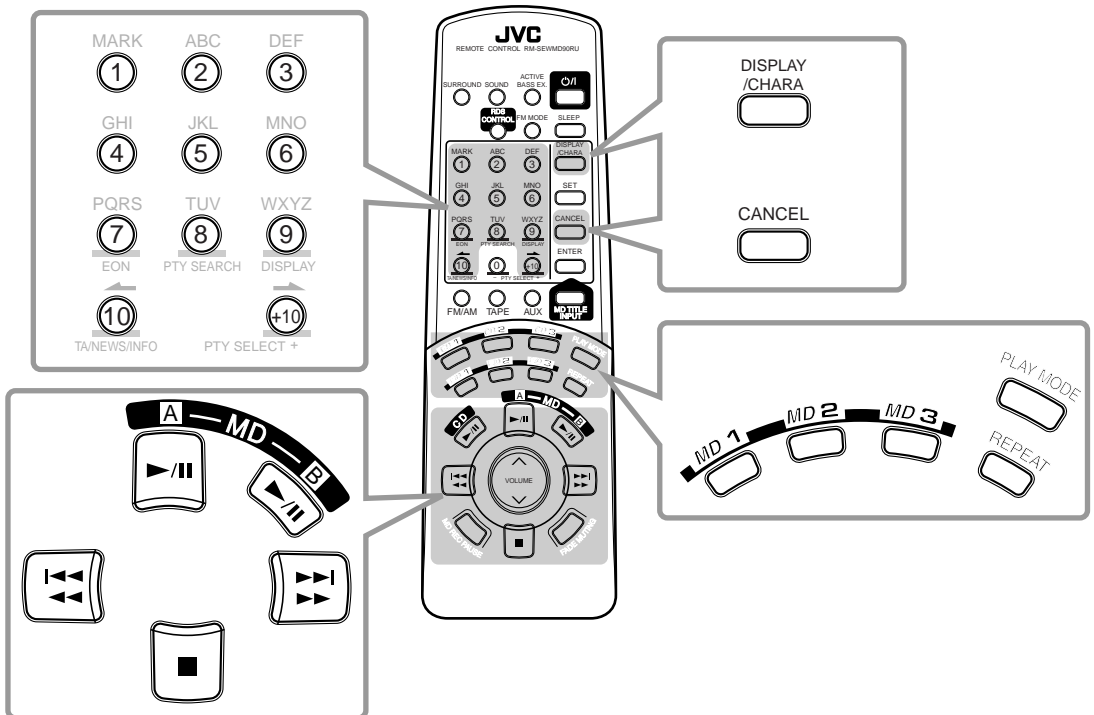

When using the remote control, make sure that it is ready for MD operations.

- Pressing MD 1, MD 2, MD 3, MD A ►/■, or MD B ►/■ on the remote control makes the remote control ready for MD operations.

Loading MDs

When using MD deck A:

- 1 Insert an MD into the MD deck A loading slot.
The MD is pulled in automatically.
The MD A operation lamps light.

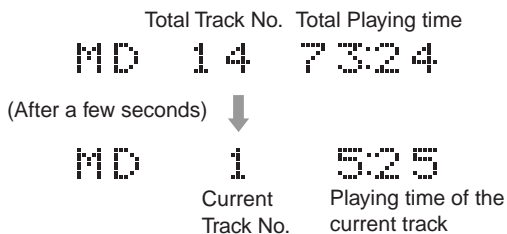
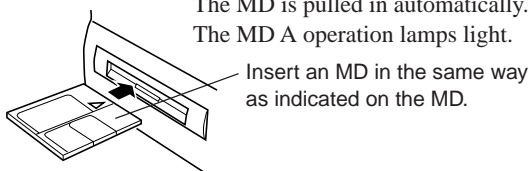

To remove the MD, press ▲ for MD deck A.

When using MD deck B:

- 1 Press ▲ for MD deck B.
The MD B loading slot cover opens automatically, and the MD number lamps light.
- 2 Place up to 3 MDs into the loading slots.

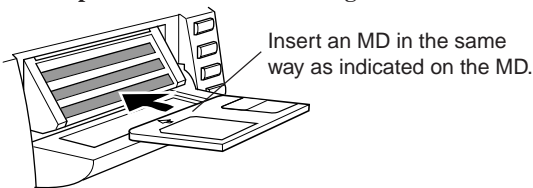

- 3 Press ▲ again to close the loading slot cover.
 - MD number lamps remain lit if an MD is inserted in the corresponding slots.
 - MD number lamps go off if no MD is inserted in the corresponding slots.

To remove MDs, press ▲ for MD deck B.

- During play, you cannot eject the currently playing MD.



About the MD A operation lamps and the MD number lamps (MD 1 to MD 3 buttons)

MD A operation lamps correspond to the MD deck A loading slot, and each MD number lamp corresponds to the MD deck B loading slot of the same number.

- It lights green when the unit has recognized that there is an MD in the corresponding loading slot.
- It flashes while an MD in the corresponding loading slot is played back.

Playing Back the Entire MD — Continuous Play

When using MD deck A:

You can play an MD in MD deck A.

- 1 Insert an MD into the MD deck A loading slot.
- 2 Press ► / ■ on MD deck A (or MD A ►/■ on the remote control).

MD playback starts from the first track.

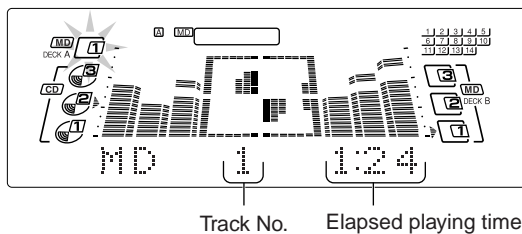

To stop during play, press ■ for MD deck A.

When using MD deck B:

You can play MDs in MD deck B continuously.

- 1 Insert MDs into the MD B loading slots.
- 2 Press one of the MD number buttons (MD 1, MD 2 and MD 3) for the MD you want to play.
MD playback starts from the first track of the selected disc.

This shows the currently selected disc.

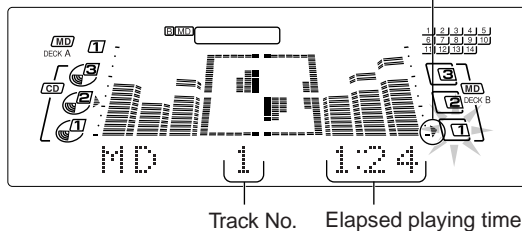

- Pressing ► / ■ for MD deck B (or MD B ►/■ on the remote control) instead of the MD number buttons starts playing back the currently selected MD.

To stop during play, press ■ for MD deck B.



MD playback sequence on MD deck B

When 3 MDs are loaded in MD deck B loading slots, they are played in one of the following sequences.

- When MD 1 is pressed : MD 1 ⇒ MD 2 ⇒ MD 3 (then stops)
 - When MD 2 is pressed : MD 2 ⇒ MD 3 ⇒ MD 1 (then stops)
 - When MD 3 is pressed : MD 3 ⇒ MD 1 ⇒ MD 2 (then stops)
- * If no MD is in the loading slot, MD deck B skips that slot.

Basic MD Operations

While playing an MD, you can do the following operations.

To stop playback for a moment

When using MD deck A: Press ▷ / || on MD deck A (or MD A ►/|| on the remote control).

To resume play, press the button again.

When using MD deck B: Press ▷ / || on MD deck B (or MD B ►/|| on the remote control).

To resume play, press the button again.

To locate a particular point in a track during play

On the unit:

Rotate the *left* jog dial.

- Counterclockwise (◀◀): Fast reverses the tracks.
- Clockwise (▶▶): Fast forwards the tracks.

On the remote control:

Press and hold ◀◀◀◀ or ▶▶▶▶.

- ◀◀: Fast reverses the tracks.
- ▶▶: Fast forwards the tracks.

To go to another track

On the unit:

Rotate the *right* jog dial.

- Counterclockwise (◀◀): Goes back to the beginning of the current or previous tracks.
- Clockwise (▶▶): Skips to the beginning of the next tracks.

On the remote control:

Press ◀◀◀◀ or ▶▶▶▶ repeatedly.

- ◀◀◀: Goes back to the beginning of the current or previous tracks.
- ▶▶▶: Skips to the beginning of the next or succeeding tracks.

To go to another track directly using the number buttons

Pressing the number button(s) allows you to start playing the track number you want.

- Ex.: For track number 5, press 5.
 For track number 15, press +10, then 5.
 For track number 20, press +10, then 10.
 For track number 32, press +10, +10, +10, then 2.

To change the display indications

Each time you press DISPLAY/CHARA, the indications in the main display changes as follows:

Before play:

For MD deck A

Track No. & playing time ↔ Disc Title

For MD deck B

Track No. & playing time → Remaining recording time on the disc
 Disc Title ←

During play:

Track No. & Elapsed playing time ↔ Track Title



If a title cannot be shown at a time

The unit scrolls the title.



If there is no title

“NO TITLE” will appear when you change the display indication.

To exchange MDs during playback of another (ONLY for MD deck B)

If MDs are exchanged during playback, playback will stop after playing all newly inserted MDs.

- 1 Press ▲ for MD deck B to open the disc loading slot cover.
- 2 Replace MDs.
- 3 Press ▲ for MD deck B again to close the disc loading slot cover.



When you open the MD loading slot cover to replace MDs

The slot of the currently playing appears empty. Do not put any MD in this slot. If you put an MD in this slot and close the cover, the cover automatically opens (“OCCUPIED” appears in the main display).

When using MD deck B:

1 Insert MDs.

- If the current playing source is not the MD deck, press $\triangleright / \parallel$ on MD deck B (or MD B $\triangleright / \parallel$ on the remote control), then \blacksquare for the MD deck B (or \blacksquare on the remote control) before going to the next step.

2 Press PLAY MODE so that “MD PROGRAM” appears in the main display.

- Each time you press the button, play mode changes as follows:

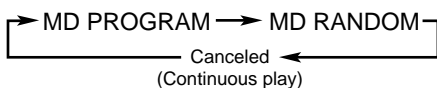

3 Press one of the MD number buttons (MD 1, MD 2, and MD 3) to select the MD number you want to play.

Ex. Disc No. 2 is selected

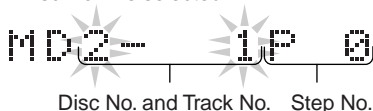

4 Select the track from the MD selected in the above step.

On the unit:

Rotate the *right* jog dial to select the track number, then press SET.

On the remote control:

Press the number buttons.

- For how to use the number buttons, see “To go to another track directly using the number buttons” on page 25.

Ex. Track No. 8 is selected



5 Program other tracks you want.

- To program tracks from the same disc, repeat step 4.
- To program tracks from a different disc, repeat steps 3 and 4.

6 Press $\triangleright / \parallel$ on MD deck B (or MD B $\triangleright / \parallel$ on the remote control).

The tracks are played in the order you have programmed.

To stop during play, press \blacksquare on MD deck B.

To exit from program play mode, press PLAY MODE once or twice, before or after play, so that the unit enters another playback mode (Random play or Continuous play mode).

To check the program contents

Before playing, you can check the program contents by pressing \lll or \ggg on the remote control.

- \ggg : Shows the programmed tracks in the programmed order.
- \lll : Shows them in the reverse order.

To modify the program

Before playing, you can erase the programmed track shown on the display by pressing CANCEL.

Each time you press the button, the programmed track shown on the display is erased from the program.

- Pressing \blacktriangle for MD deck B *before or after play*, the entire program is erased.
- Pressing \blacktriangle for MD deck B *during play*, the programmed tracks from the MD not playing are erased from the program.

To add tracks in the program before you start play, simply select track numbers you want to add.



If you try to program a 33rd step
“MD FULL” will appear on the display.



If your entry is ignored
You have tried to program a track that does not exist on the MD (for example, selecting track 14 on an MD that only has 12 tracks). Such entries are ignored.



Playing at Random — Random Play

The tracks of the loaded MDs will play at random.

1 Insert an MD.

- If the current playing source is not the MD deck:
 - When using MD deck A:** Press \triangleright / \parallel on MD deck A (or MD A \blacktriangleright / \parallel on the remote control), then \blacksquare for MD deck A (or \blacksquare on the remote control) before going to the next step.
 - When using MD deck B:** Press \triangleright / \parallel on MD deck B (or MD B \blacktriangleright / \parallel on the remote control), then \blacksquare for MD deck B (or \blacksquare on the remote control) before going to the next step.

2 Press PLAY MODE repeatedly until “MD RANDOM” appears in the main display.

- Each time you press the button, play mode changes as follows:

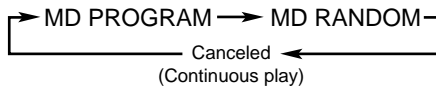

3 Start play.

- When using MD deck A:** Press \triangleright / \parallel on MD deck A (or MD A \blacktriangleright / \parallel on the remote control). The tracks are played at random. Random play ends when all the tracks are played once.
 - Random play also ends when you eject the MD.
- When using MD deck B:** Press \triangleright / \parallel on MD deck B (or MD B \blacktriangleright / \parallel on the remote control). The tracks of all inserted MDs are played at random. Random play ends when all the tracks are played once.
 - You can eject MDs not playing and exchange them during play (without ending random play).

To skip the playing track, rotate the *right jog dial* clockwise or press $\blacktriangleright\blacktriangleright\blacktriangleright$ on the remote control.

- You cannot go back to the previous tracks by rotating the *right jog dial* counterclockwise or pressing $\blacktriangleleft\blacktriangleleft$ on the remote control.

To stop during play, press \blacksquare for the MD deck currently used.

To exit from Random play mode, press PLAY MODE once or twice, before or after play, so that the unit enters another playback mode (Continuous play or Program play mode).

Repeating Tracks — Repeat Play

You can have all the tracks, the program or the individual track currently playing repeat as many times as you like.

To repeat play, press REPEAT during or before playing. Each time you press the button, Repeat play mode changes, and the REPEAT indicator changes to light as follows:

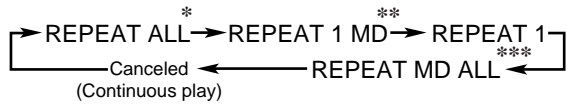

REPEAT ALL: Repeats all the tracks of all MDs in MD deck B continuously or at random, or all the tracks in the program.

- REPEAT 1 MD:**
- Repeats the MD in MD deck A continuously or at random, or all the tracks in the program.
 - Repeats an MD in MD deck B continuously.

REPEAT 1: Repeats one track.

REPEAT MD ALL:

Repeats all loaded MDs in MD decks A and B continuously. “4MD PLAY” appears during play.

- * You can select “REPEAT ALL” only when using MD deck B.
- ** If you press PLAY MODE while using MD deck B, “REPEAT 1 MD” is canceled.
- *** If you press PLAY MODE, “REPEAT MD ALL” is canceled.

To cancel Repeat play, press REPEAT repeatedly until no REPEAT indicator lights on the display.

To prohibit disc ejection — Disc Lock

You can prohibit CD and MD ejection from the unit, and can lock discs.

See page 22 for details.

Recording on MDs

The buttons and controls enlarged in the illustration below are used and explained in this section (pages 30 to 37).

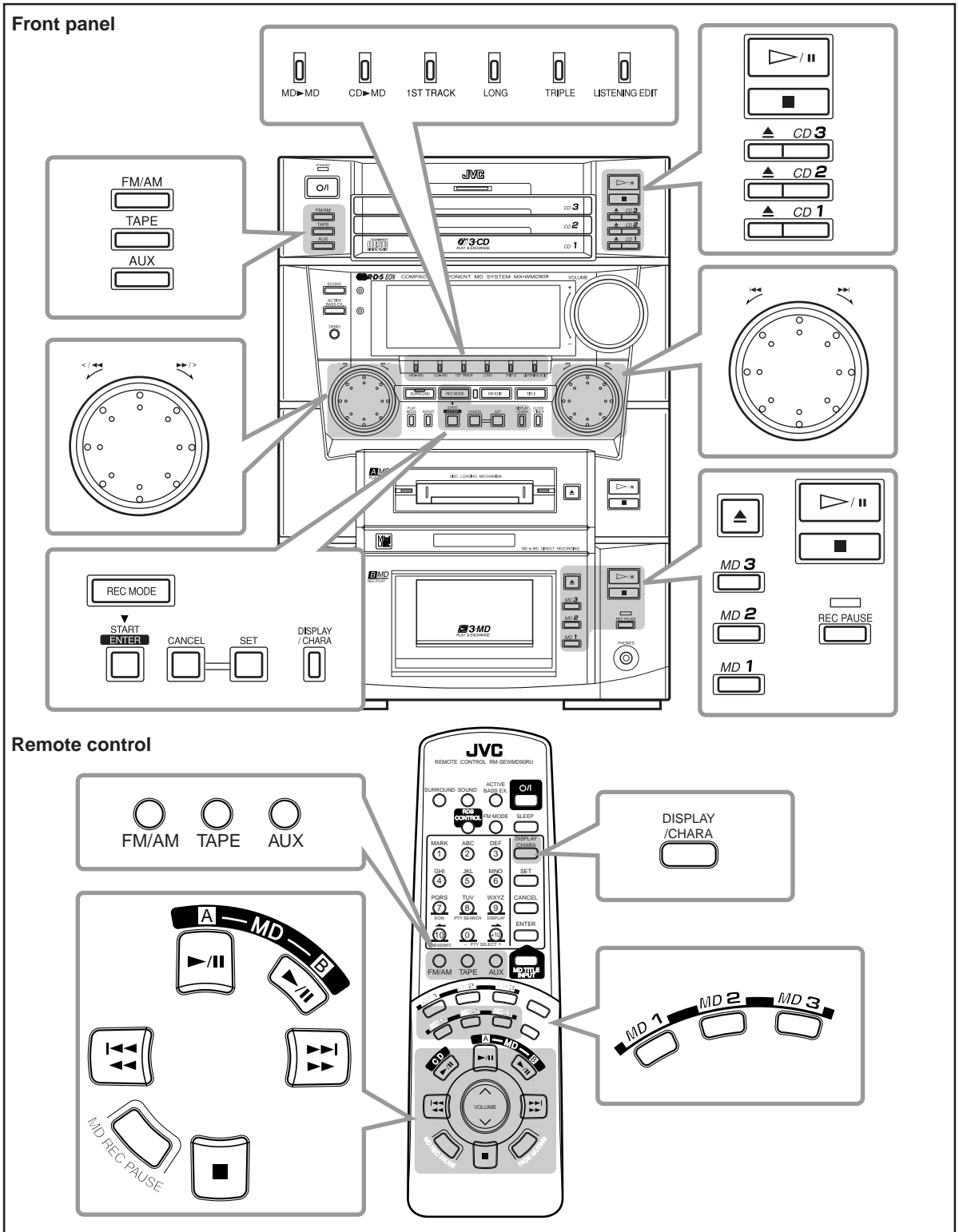

Before You Start Recording

- Recording is only possible on MD deck B.
- It may be unlawful to record or play back copyrighted material without the consent of the copyright owner.**
- When you record onto partially recorded MD, its contents are not erased or overwritten. The recording starts from the point following the last recorded track of the MD.
If you want to record on such an MD from the beginning, you have to erase its contents first (see “ALL ERASE Function” on page 43).
- The recording level is automatically set correctly, so it is not affected by the VOLUME control. Thus, during recording you can adjust the sound you are actually listening to without affecting the recording level.
- While recording, you can hear sound mode effect and/or the active bass extension effect through the speakers or headphones. However, the sound is recorded without these effects (see page 12).

About the track marks

When playing an MD, you can move among the tracks. You can do this because there is a mark recorded at the beginning of each track enabling you to locate the track. This mark is called a “**track mark**” and the portion between two adjacent track marks is called a “**track**.”

- When recording from the CD player or MD deck A built in this unit,** a track mark is recorded automatically at the beginning of each track.
- When recording an analog or digital source using Standard Recording (see page 31) or AUX Recording (see page 31) and when recording an analog source using Long Recording (see page 37),** no track mark is recorded on the MD. This means that, when playing this MD, the MD deck B will regard the entire recording as one track (track 1). You will not be able to select directly a song or navigate through songs.

However, if no sound comes in for about 3 seconds or more while recording, the MD deck B will consider it as a blank separating 2 tracks and consequently put a track mark.

To put a track mark manually while recording, press SET at the place where you want to put a track mark.

- To add a track mark after recording is over,** you can use the DIVIDE function (see page 40).

To avoid erasing important recordings

Recordable MDs have an erasure prevention tab so that important recordings are not accidentally erased. When you finish recording or editing, slide open the erasure prevention tab on the cartridge side surface. New recording or editing is now no longer possible. (If you try to do, “DISC PROTECTED” appears in the main display.) To do re-recording or editing, return the tab to the closed position.

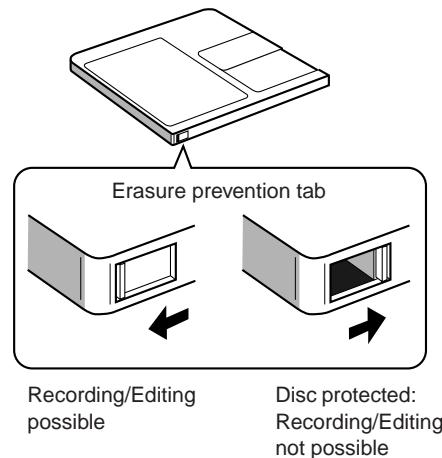

If “PLAY BACK” appears in the main display when you try to record on an MD

The MD is only for playback use, not for recording.

When using the remote control, make sure that it is ready for MD operations.

- Pressing MD 1, MD 2, MD 3, MD A ►/||, or MD B ►/|| on the remote control makes the remote control ready for MD operations.

Recording FM/AM (MW/LW) Broadcasts or from the Cassette Deck – Standard Recording

You can record FM/AM (MW/LW) broadcasts or sounds from the equipment connected to the TAPE jacks on the rear.

- 1 Insert a blank or recordable MD into the MD B loading slot.**
- 2 When recording a broadcast program, press FM/AM, then tune into a station you want.**
 - See “Tuning in a station” on page 14.

When recording from the cassette deck, press TAPE.
- 3 Press REC PAUSE on the unit (or MD REC PAUSE on the remote control).**

The REC PAUSE lamp and the disc number lamps, if MDs are inserted into the corresponding slots, start flashing red.
- 4 Press the MD number button (MD 1 to MD 3) corresponding to the slot number where you insert the MD.**

Only the selected MD number lamps continues flashing.
- 5 When recording from the cassette deck, start playing a tape.**
 - Refer to the manual supplied with the cassette deck.
- 6 Press ▷ / || on MD deck B (or MD B ►/|| on the remote control).**

The REC PAUSE lamp and the disc number lamp stop flashing and remain lit, and recording starts.

To stop recording, press ■ for MD deck B.

To stop recording temporarily, press REC PAUSE (or MD REC PAUSE on the remote control) again.

To resume recording, press ▷ / || on MD deck B (or MD B ►/|| on the remote control) again.

To remove the MD, press ▲ for MD deck B.

To check the remaining time

Press DISPLAY/CHARA while recording.

The remaining recording time of the MD appears for a while.



About the MD number lamps (MD 1 to MD 3 buttons) while recording

- It lights red during recording.
- It flashes during recording pause.

Recording the External (AUX) Equipment – AUX Recording

Both analog and digital recording is possible from the external equipment connected to the AUX jacks.

For digital recording: Connect;

- Between the optical digital output terminal on the other equipment and the AUX DIGITAL IN OPTICAL terminal, by using an optical digital cord (not supplied).
- Between the audio output jacks on the other equipment and the AUX jacks, by using an audio cord (not supplied). Without connecting the audio cord, you cannot listen to the source sound while recording.

- 1 Insert a blank or recordable MD into the MD B loading slot.**
- 2 Press AUX once.**
- 3 Press REC PAUSE on the unit (or MD REC PAUSE on the remote control).**

The REC PAUSE lamp and the disc number lamps, if MDs are inserted into the corresponding slots, start flashing red.
- 4 Press AUX again.**
 - Each time you press the button, analog or digital input is selected alternately.

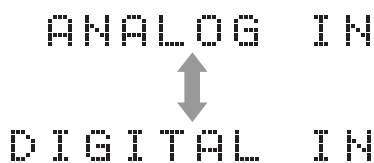

ANALOG IN: Enables analog recording through the audio cord connected to the AUX jacks.

DIGITAL IN: Enables digital recording through the optical digital cord connected to the AUX DIGITAL IN OPTICAL terminal. A sampling rate converter built in this unit allows you to record from a digital device whose sampling frequency is 32 kHz, 44.1 kHz, or 48 kHz.

5 Press the MD number button (MD 1 to MD 3) corresponding to the slot number where you insert the MD.

Only the selected MD number lamps continues flashing.

6 Start playing the source on the external equipment.

- Refer to the manual supplied with the external equipment.

7 Press ▷ / || on MD deck B (or MD B ▶/|| on the remote control).

The REC PAUSE lamp and the MD number lamp stop flashing and remain lit, and recording starts.

To stop recording, press ■ for MD deck B.

To stop recording temporarily, press REC PAUSE (or MD REC PAUSE on the remote control) again.

To resume recording, press ▷ / || on MD deck B (or MD B ▶/|| on the remote control) again.

To remove the MD, press ▲ for MD deck B.

Various Recording Functions

You have 5 powerful and convenient recording methods. Among them, only Long Recording method can be used for any sound source; while the others can be used for CD or MD.

- **Synchronized Recording** — Records the entire CD or MD (or the program you have made).
- **First Track Recording** — Records the first track of each CD.
- **Triple Recording** — Records 3 CDs onto 3 MDs.
- **Listening Edit Recording** — Allows you to make a program while listening to the CD or MD.
- **Long Recording** — Records a long radio program or another source continuously on 3 MDs.

While recording CD using the recording methods listed above, you can listen to MD deck A, cassette deck, and AUX. While the *left* jog dial is flashing slowly, rotate it to change the source. In this case, you cannot use the *left* jog dial to operate the MD deck A.

Synchronized Recording

This is the easiest way of CD and MD recording.

MD to MD Synchronized Recording

You can play back an MD in MD deck A and record it onto another MD in MD deck B.

- Using the following method allows you only analog recording.
- Before you start recording in the following steps, you can —
 - cancel the setting, press REC MODE.
 - go back to the previous steps, press CANCEL.

On the unit ONLY:

1 Insert a source MD into the MD A loading slot.

2 Insert a blank or recordable MD into the MD B loading slot.

3 Press REC MODE.
“MD ▶ MD REC?” appears in the main display.
The MD ▶ MD lamp lights.

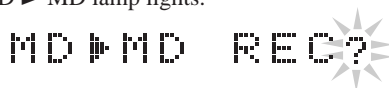

4 Press SET.



5 Rotate the *left* jog dial to select the MD to record onto.

Ex. MD 1 is selected

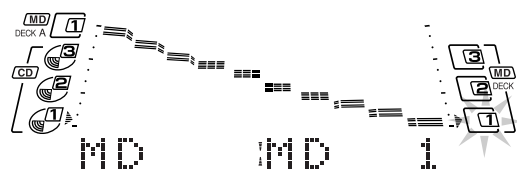

6 Press START (ENTER).

Recording starts, and the following information appears in the main display.

3:15 ▶ 7:12:5

Remaining time of the source track Remaining time on the MD

When recording is over, both MD decks stop.

- When you record on a blank MD, the disc title of the source MD is automatically recorded (up to 64 characters).
- A blank portion will be automatically created before each newly recorded track.

To stop recording, press ■ either for MD deck A or B.

To remove the MDs, press ▲ for MD deck A and for MD deck B.

To confirm the recording contents

Press DISPLAY/CHARA while recording.

The following information will appear on the display for a while.

- Track No. of the source MD
- Track No. of the current recording on the other MD

CD to MD Synchronized Recording

You can play back a CD and record it onto an MD in MD deck B.

- Before you start recording in the following steps, you can —
 - cancel the setting, press REC MODE.
 - go back to the previous steps, press CANCEL.

On the unit ONLY:

1 Load a CD.

- You can make a program if you want (see page 21).

2 Insert a blank or recordable MD into the MD B loading slot.

3 Press REC MODE.

“MD ▶ MD REC?” appears in the main display.
The MD ▶ MD lamp also lights.

MD ▶ MD REC?

- **To cancel the setting**, press REC MODE again in the following steps 4 and 6. Each time you press the button, recording mode turns on and off alternately.

4 Rotate the left jog dial until “CD ▶ MD REC?” appears in the main display.

CD ▶ MD REC?

5 Press SET.

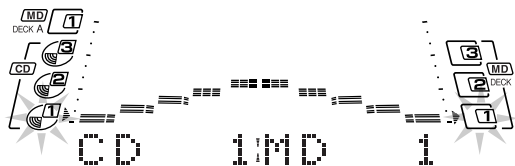

6 Rotate the left jog dial to select the source CD and the recordable MD.

Ex. CD 2 and MD 3 are selected

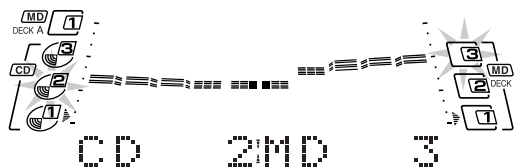

7 Press START (ENTER).

Recording starts, and the following information appears in the main display.

3:15 ▶ 7:12:5

Remaining time of the source track Remaining time on the MD

When recording is over, both MD deck B and CD player stop.

To stop recording, press ■ either for CD player or MD deck B.

To remove the CD, press ▲ for the corresponding CD number.

- If you eject the CD currently playing, recording stops.

To remove the MD, press ▲ for MD deck B.

- If you press the button while recording, the loading slot cover does not open.

To confirm the recording contents

Press DISPLAY/CHARA while recording.

The following information will appear on the display for a while.

- Track No. of the source CD
- Track No. of the current recording on the MD

To record a single track while playing an MD or CD – Single Track Recording
 Press START (ENTER) while playing back a track you want to record.
 The playback of that track is stopped, and the same track starts playing from the beginning again. This time, the MD deck B starts recording the track onto the currently selected MD in MD deck B.

First Track Recording

First Track Recording allows you to record the first track of each loaded CD. You can, for example, make a directory of all your best CDs.

- Before you start recording in the following steps, you can —
 - cancel the setting, press REC MODE.
 - go back to the previous steps, press CANCEL.

On the unit ONLY:

- 1 Load CDs.**
 - Always place a CD on the CD 1 tray. If not, this function does not work.
- 2 Insert a blank or recordable MD into the MD B loading slot.**
- 3 Press REC MODE.**

“MD ► MD REC?” appears in the main display.
 The MD ► MD lamp also lights.
- 4 Rotate the left jog dial until “1ST TRACK REC?” appears in the main display.**

The 1ST TRACK and CD ► MD lamps light.

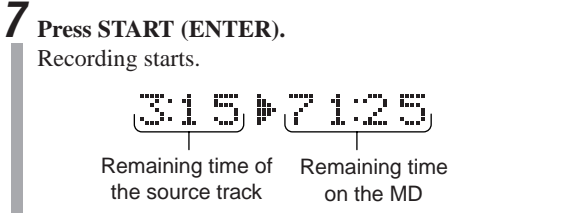
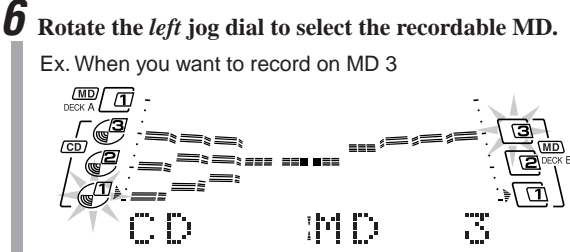
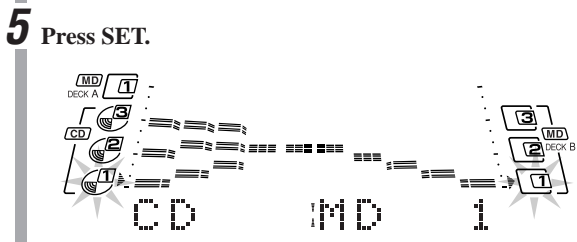
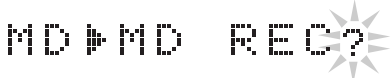

After the first track of the CD on the CD 1 tray is recorded, the first track of the CD on the CD 2 tray will be recorded.

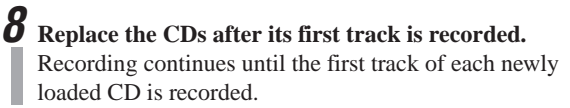

To stop recording, press ■ either for CD player or MD deck B.

To remove the CD, press ▲ for the corresponding CD number.
 • If you eject the CD currently playing, recording stops.

To remove the MD, press ▲ for MD deck B.
 • If you press the button while recording, the loading slot cover does not open.

To confirm the recording contents
 Press DISPLAY/CHARA while recording.
 The following information will appear on the display for a while.

- Track No. of the source CD
- Track No. of the current recording on the MD

Listening Edit Recording

Listening Edit Recording allows you to make a program while listening and checking each track of the loaded CDs (up to 3 CD) or an MD in MD deck A, then to start recording the program.

- You can program up to 32 tracks.
- Before you start recording in the following steps, you can —
 - cancel the setting, press REC MODE.
 - go back to the previous steps, press CANCEL.

On the unit ONLY:

1 Prepare a CD or an MD as the source sound.

- To use a CD as the source:
Always place a CD on the CD 1 tray. If not, this function does not work.
- To use an MD as the source:
Insert a source MD in the loading slot of MD deck A.

2 Insert a blank or recordable MD into the MD B loading slots.

3 Press REC MODE.

“MD ► MD REC?” appears in the main display.
The MD ► MD lamp also lights.

MD ► MD REC?

4 Rotate the left jog dial until “LISTENING?” appears in the main display, and the correct recording mode lamp (CD ► MD or MD ► MD) lights on the unit.

- To use a CD as the source:
Light the LISTENING EDIT and CD ► MD lamps.
- To use an MD as the source:
Light the LISTENING EDIT and MD ► MD lamps.

LISTENING?

5 Press SET.

Ex. CD is selected as the source

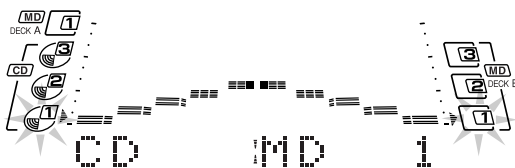

6 Rotate the left jog dial to select the recordable MD.

Ex. MD 3 is selected as the recordable MD

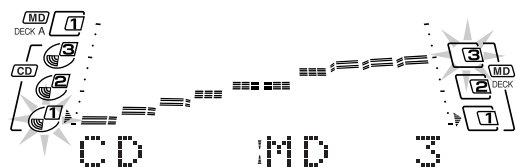

7 Press SET.

Playback of the source disc starts.

- When the source is CD, playback starts from CD 1 to CD 3 if two or three CDs are loaded.

3:15 ▶ 7:25

Playing time of the source track Remaining time on the MD

8 Decide if you want to include the current track in the program or skip it.

- **To include the current playing track in the program, press SET.**
The current track is programed (“MEMORY” appears for a while) and the next track starts playing. (After the last track of a CD is programed, the first track of the next CD starts playing.)
- **To skip the current track, press CANCEL or rotate the right jog dial clockwise.**
The current playing track is not programed and the next track starts playing.

If you do not either press the button or rotate the right jog dial, the unit will play the same track repeatedly.

9 Repeat step 8 to program other tracks.

When you finish checking all tracks or if there is no more remaining time for recording on the MD, Listening Edit Recording starts automatically.

- If the remaining time of the MD becomes short, MD deck B will search for a track fitting into the remaining time. To include the track found in the program, press SET. To find another, press CANCEL.

To stop any time during editing process and start recording, press START (ENTER).

To stop recording:

When recording from CD player: Press ■ either for CD player or MD deck B.

When recording from MD deck A: Press ■ either for MD deck A or MD deck B.

To remove the CD, press ▲ for the corresponding CD number.

- If you eject any CD during editing, editing is canceled.
- If you eject any CD during recording, recording stops.

To remove the MD from MD deck A, press ▲ for MD deck A.

- If you eject the MD during editing, editing is canceled.
- If you eject the MD during recording, recording stops.

To remove the MD from MD deck B, press ▲ for MD deck B.

- If you press the button while recording, the disc loading slot cover does not open.

To confirm the recording contents

Press DISPLAY/CHARA while recording.

The following information will appear on the display for a while.

- Track No. of the source CD or MD
- Track No. of the current recording on the MD

Triple Recording

You can record three CDs onto three MDs.

- Before you start recording in the following steps, you can —
 - cancel the setting, press REC MODE.
 - go back to the previous steps, press CANCEL.

On the unit ONLY:**1 Prepare CDs.**

- Always place a CD on the CD 1 tray. If not, this function does not work.
- If you want to record two CDs onto two MDs, use the CD 1 and 2 trays.

2 Insert blank or recordable MDs into the MD B loading slots.

- Always place an MD on the MD 1 loading slot. If not, this function does not work.
- If you want to record two CDs onto two MDs, use the MD 1 and 2 loading slots.

3 Press REC MODE.

“MD ► MD REC?” appears in the main display. The MD ► MD lamp also lights.

MD ► MD REC?

4 Rotate the left jog dial until “TRIPLE REC?” appears in the main display.

The TRIPLE REC and CD ► MD lamps light.

TRIPLE REC?

5 Press START (ENTER).

Recording starts, and the tracks of CD 1 are recorded onto MD 1, CD 2 onto MD 2, and CD 3 onto MD 3. (If CD 2 or MD 2 is missing, recording stops when MD 1 is recorded.)

To stop recording, press ■ either for CD player or MD deck B.

To remove the CD, press ▲ for the corresponding CD number.

- If you eject the CD currently playing, recording stops.

To remove the MD, press ▲ for MD deck B.

- If you press the button while recording, the loading slot cover does not open.

To confirm the recording contents

Press DISPLAY/CHARA while recording.

The following information will appear on the display for a while.

- Track No. of the source CD
- Track No. of the current recording on the MD



Long Recording

You can record any source continuously onto three MDs, enabling you to make a long recording of radio programs, or to record three CDs continuously, etc.

- With this function, MDs are always recorded in stereo.
- Before you start recording in the following steps, you can —
 - cancel the setting, press REC MODE.
 - go back to the previous steps, press CANCEL.

On the unit ONLY:

1 Insert blank or recordable MDs into the MD B loading slots.

- Always place an MD on the MD 1 loading slot. If not, this function does not work.
- If you want to record onto two MDs, use the MD 1 and 2 loading slots.

2 Prepare the source you want to record from.

- To use a CD as the source:
 - Always place a CD on the CD 1 tray. If not, this function does not work.
 - Select the first disc to play, by pressing the CD number button, then ■ for CD player.
- To use the FM/AM (MW/LW) tuner as the source: Tune into a station. See “Tuning in a station” on page 14.
- To use the external component (AUX) as the source: Play the source you want to record.

3 Press REC MODE.

“MD ► MD REC?” appears in the main display. The MD ► MD lamp also lights.

MD ► MD REC?

4 Rotate the left jog dial until “LONG REC?” appears in the main display.

The LONG REC lamp also lights.

LONG REC?

5 Press SET.

CD ► MD 1

6 Rotate the left jog dial to select the source sound and the recordable MD.

Ex. FM station is recorded onto MD1

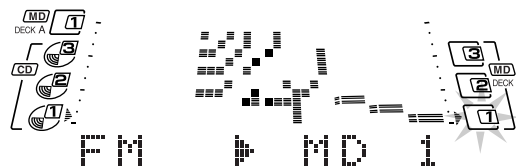

- When you select “CD” as the source sound, the CD ► MD lamp also lights.

7 Press START (ENTER).

Recording starts from MD 1, MD 2 to MD 3.

- When recording a CD:
The currently selected CD starts playing. The remaining play time of the track and the remaining recording time on the MD appear in the main display.
- When recording an FM or AM (MW/LW) station:
The station frequency appears in the main display.
- When recording from the external component (AUX/TAPE):
“AUX” or “TAPE” appears in the main display.

After MD 3 is recorded, MD deck B stops. (If MD 2 is missing or has little recording time available, recording stops after MD 1 is recorded.)

To stop recording:

When recording a CD: Press ■ either for CD player or MD deck B.

When recording other sources: Press ■ for MD deck B.

To remove the MDs, press ▲ for MD deck B.

- If you press the button while recording, the disc loading slot cover does not open.

To confirm the recording contents

Press DISPLAY/CHARA while recording.

The following information will appear on the display for a while.

When recording a CD:

- Track No. of the source CD
- Track No. of the current recording on the MD

When recording other sources:

- Source name
- Track No. of the current recording on the MD

The buttons and controls enlarged in the illustration below are used and explained in this section (pages 39 to 43).

Front panel

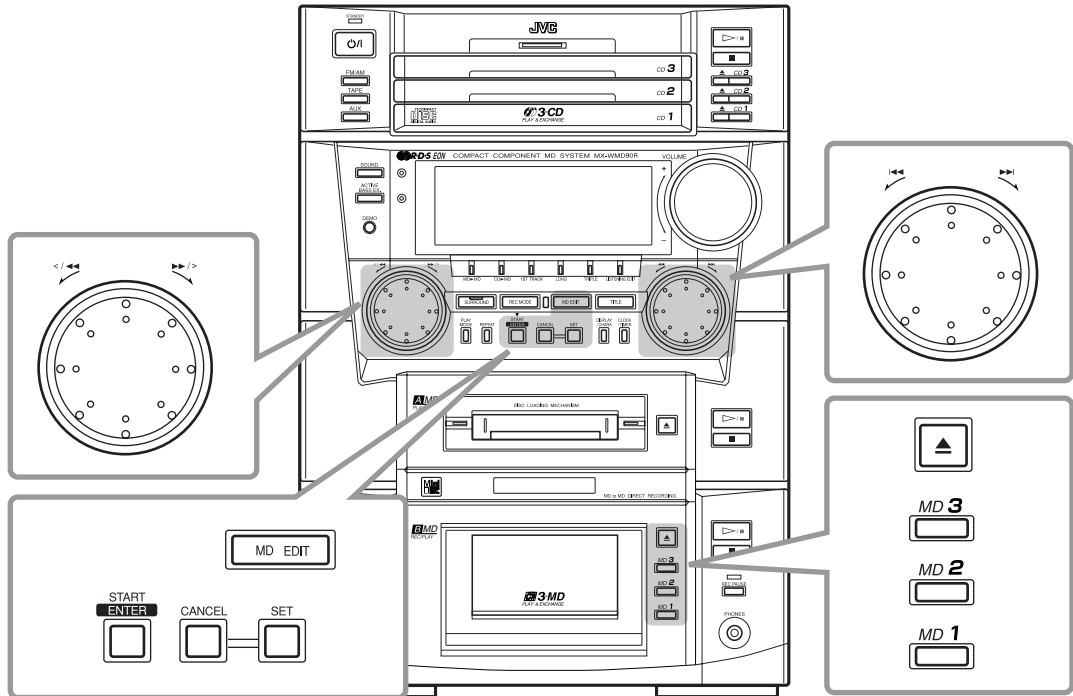

**You cannot use the remote control to edit MDs.
Use only buttons on the front panel.**

Introducing MD Editing Functions

A recorded MD can be edited in many ways. The MD editing functions include dividing, joining, moving, erasing a single track, erasing the entire disc, and more than one of them can be combined as required.

- MD editing is only possible on MD deck B.

Dividing a track (DIVIDE) : Page 40

This function divides a track by adding a track marking(s) in the desired point(s) in the middle or where you want to search later.

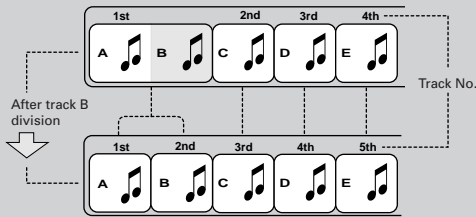

Joining a track (JOIN) : Page 41

This function joins two adjacent tracks into a single track by deleting a track marking.

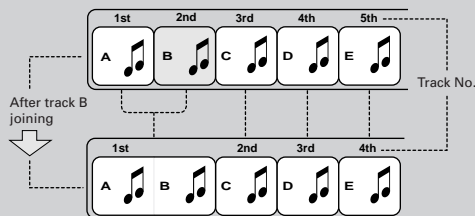

Moving a track (MOVE) : Page 41

This function moves a track by reordering the track numbers.

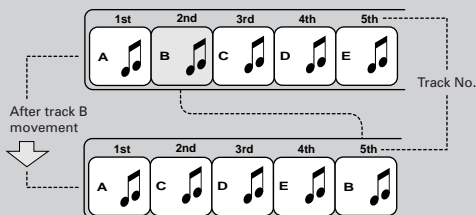

Erasing a track (ERASE) : Page 42

This function erases a specified track. After the erasure, the subsequent tracks are justified and their track numbers are renumbered automatically.

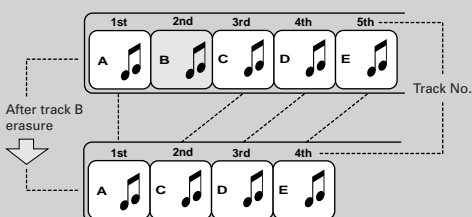

Erasing all tracks (ALL ERASE) : Page 43

This function erases data in a disc entirely.

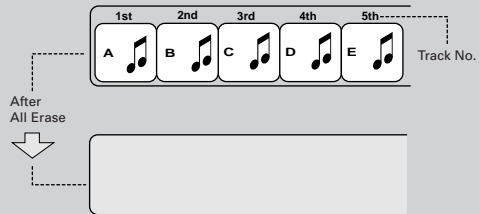

Erasing a Portion of a Track

By combining "DIVIDE", "ERASE" and "JOIN", for example, it is possible to erase only a part of an existing track.

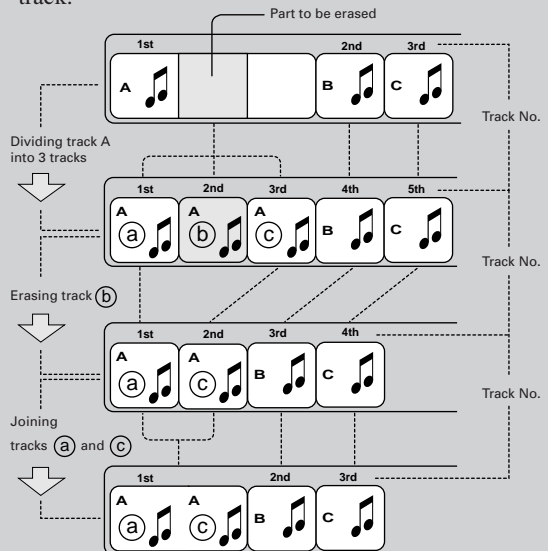

If "PLAY BACK" or "DISC PROTECTED" appears when you try to edit an MD

You cannot edit such MDs. See page 57.



You can also assign titles to MDs and/or tracks (See page 44.)

A title can be assigned to a track or disc. Once a title is assigned, it is displayed in later playback for confirmation.





Each title can be composed of up to 64 characters, and can be input using alphabetic characters (uppercase and lowercase), symbols and numerals.

DIVIDE Function

This function allows you to divide one track into two separate tracks. It is useful, for example, when you want to add track marks at a certain point within a track or if you want to separate a recording.

- To stop any time during editing process, press MD EDIT.

On the unit ONLY:

- 1 Insert an MD you want to edit into the MD B loading slot.**
- 2 Press one of the MD number buttons (MD 1, MD 2, and MD 3) corresponding to the MD you want to edit.**
MD deck B starts playing the MD.
- 3 Press MD EDIT.**
MD deck B enters editing mode (with DIVIDE function selected).

- 4 Press SET.**
The information of the first track (or the current track) of the MD appears in the main display.

- 5 Rotate the right jog dial to select the track you want to divide.**
The selected track starts playing.
Ex. When you want to divide track 5

- 6 Press SET when you find the point where you want to divide the track.**
MD deck B repeats the selected point — a 3-second period following the dividing point.

- If the dividing point is satisfactory, go to step 8.
- If the dividing point is not satisfactory, go to the next step.

- 7 Rotate the left jog dial to precisely adjust the dividing point.**

- You can shift the dividing point up to ± 128 . This range (± 128) corresponds to approximately ± 8 seconds from the original point (Position 0).

When you stop rotating the *left* jog dial, the unit repeats the newly selected dividing point.

- When you find the right position, go to the next step.
- If you want to cancel the dividing point, press CANCEL.

- 8 Press ENTER (START) to finish the editing procedure.**



- 9 Press \blacktriangle for MD deck B to eject the MD.**
“WRITING” appears while the editing you have made is being recorded on the MD.



To join the divided tracks again, see the JOIN function.

JOIN Function

This function allows you to join two adjacent tracks into one track.

- To stop any time during editing process, press MD EDIT.

On the unit ONLY:

1 Insert an MD you want to edit into the MD B loading slot.

2 Press one of the MD number buttons (MD 1, MD 2, and MD 3) corresponding to the MD you want to edit.
MD deck B starts playing the MD.

3 Press MD EDIT.
MD deck B enters editing mode (with DIVIDE function selected).

D I V I D E ?

4 Rotate the *right* jog dial until “JOIN ?” appears.

J O I N ?

5 Press SET.

← ← ← ← + 1 ?

6 Rotate the *right* jog dial to select the two adjacent tracks you want to join.

Ex. When you want to join tracks 4 and 5

4 + 5 ?

7 Press SET.

P U S H E N T E R

- If you have selected wrong tracks, press CANCEL, then select the correct tracks by rotating the *right* jog dial again.

8 Press ENTER (START) to finish the editing procedure.

E D I T I N G

9 Press ▲ for MD deck B to eject the MD.
“WRITING” appears while the editing you have made is being recorded on the MD.

W R I T I N G

To divide the joined tracks, see the DIVIDE function.

MOVE Function

This function allows you to move a track to the position you prefer. It is useful to change the order of the tracks as you like.

- To stop any time during editing process, press MD EDIT.

On the unit ONLY:

1 Insert an MD you want to edit into the MD B loading slot.

2 Press one of the MD number buttons (MD 1, MD 2, and MD 3) corresponding to the MD you want to edit.
MD deck B starts playing the MD.

3 Press MD EDIT.
MD deck B enters editing mode (with DIVIDE function selected).

D I V I D E ?

4 Rotate the *right* jog dial until “MOVE ?” appears.

M O V E ?

5 Press SET.

← 1 ?

6 Rotate the *right* jog dial to select the track you want to move.

Ex.: When you want to move track 5



7 Press SET.



- If you have selected a wrong track number, press CANCEL, then select the correct track number again.

8 Rotate the *right* jog dial to select the position where you want to move the track.

Ex.: When you want to move to the track 3 position



9 Press SET.

PUSH ENTER

- If you have selected wrong tracks, press CANCEL, then select the correct tracks by repeating from step 6.

10 Press ENTER (START) to finish the editing procedure.

EDITING

11 Press \blacktriangle for MD deck B to eject the MD. "WRITING" appears while the editing you have made is being recorded on the MD.

WRITING

2 Press one of the MD number buttons (MD 1, MD 2, and MD 3) corresponding to the MD you want to edit.

MD deck B starts playing the MD.

3 Press MD EDIT. MD deck B enters editing mode (with DIVIDE function selected).



4 Rotate the *right* jog dial until "ERASE ?" appears.



5 Press SET.



6 Rotate the *right* jog dial to select the track you want to erase.

Ex.: When you want to erase track 4



7 Press SET.

PUSH ENTER

- If you have selected a wrong track number, press CANCEL, then select the correct track number.

8 Press ENTER (START) to finish the editing procedure.

EDITING

9 Press \blacktriangle for MD deck B to eject the MD. "WRITING" appears while the editing you have made is being recorded on the MD.

WRITING

ERASE Function

This function allows you to erase an unwanted track.

- To stop any time during editing process, press MD EDIT.

On the unit ONLY:

1 Insert an MD you want to edit into the MD B loading slot.



ALL ERASE Function

This function allows you to erase all the tracks on an MD.

- To stop any time during editing process, press MD EDIT.

On the unit ONLY:

- 1** Insert an MD you want to edit into the MD B loading slot.
- 2** Press one of the MD number buttons (MD 1, MD 2, and MD 3) corresponding to the MD you want to edit.
MD deck B starts playing the MD.
- 3** Press MD EDIT.
MD deck B enters editing mode (with DIVIDE function selected).

D I V I D E ?

- 4** Rotate the *right* jog dial until “ALL ERASE ?” appears.

A L L E R A S E ?

- 5** Press SET.

P U S H E N T E R

- 6** Press ENTER (START) to finish the editing procedure.

E D I T I N G



B L A N K D I S C

- 7** Press \blacktriangle for MD deck B to eject the MD.
“WRITING” appears while the editing you have made is being recorded on the MD.

W R I T I N G

Assigning Titles to MDs

Continued 

The buttons and controls enlarged in the illustration below are used and explained in this section (pages 45 to 48).

Front panel

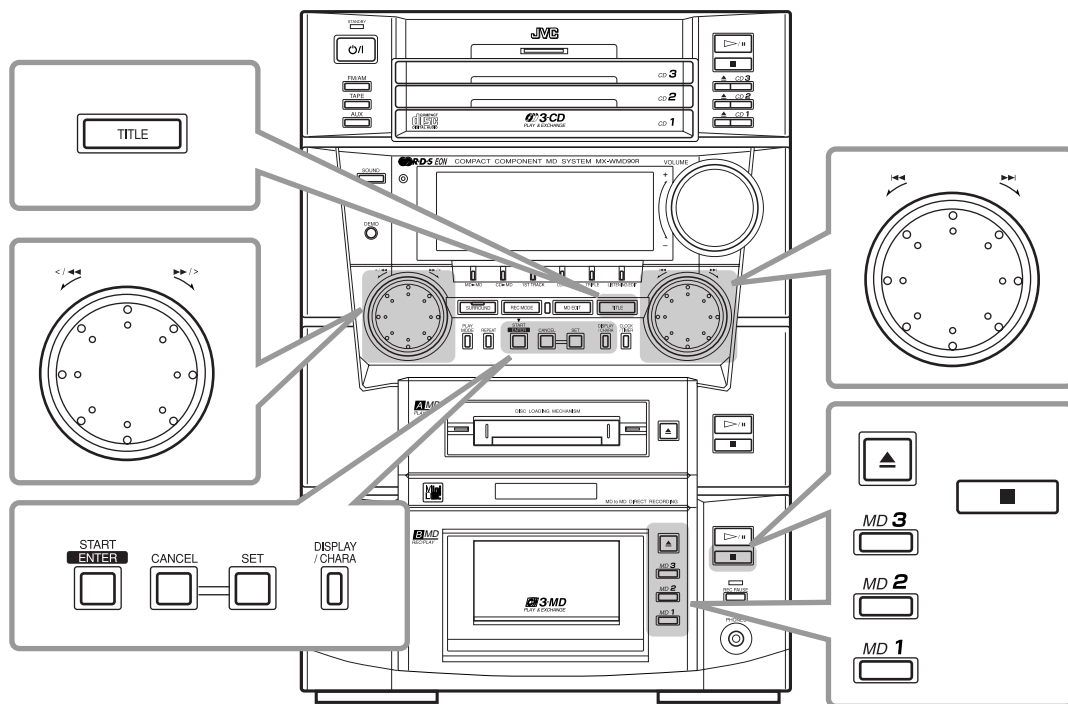

Remote control

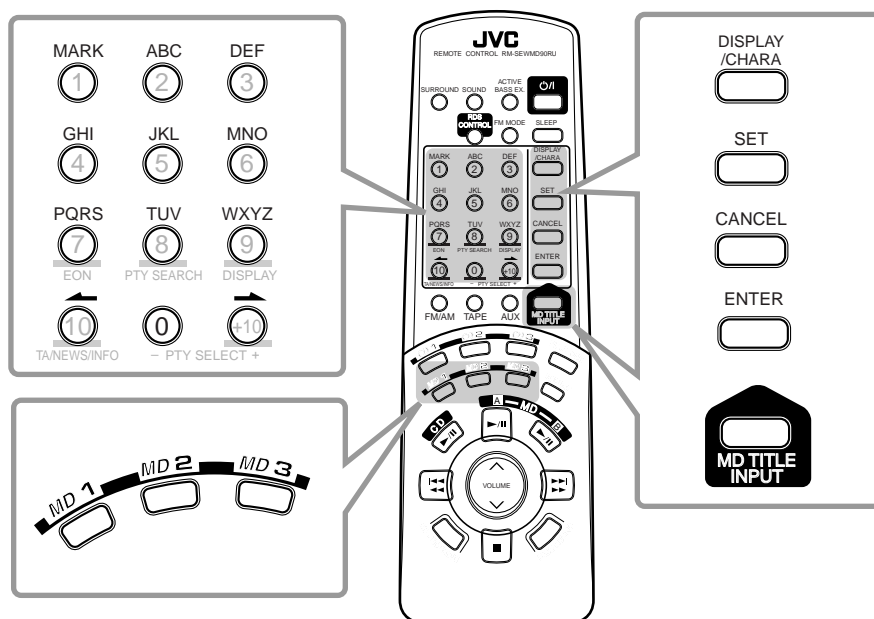

You can assign a name to each MD and to each track. Once a title is assigned, it is displayed for confirmation. Each title can be composed of up to 64 characters, and can be input using alphabetic characters (uppercase and lowercase), symbols and numerals.

Assigning a Title Using the Unit

In the following example, the process is explained from the very first — that is, inserting a disc. If you already start recording or playing, start from step 3.

- To stop any time during the process, press TITLE.

1 Insert an MD you want to edit into the MD B loading slot.

2 Press one of the MD number buttons (MD 1, MD 2, and MD 3) corresponding to the MD you want to assign titles.

MD deck B starts playing the MD.

- If you do not have to listen to the MD while assigning titles, press ■ for MD deck B to stop playing.

3 Press TITLE.

MD deck B enters title entry mode.

- Track title entry indication (mode):** appears when you press TITLE while playing or recording.

1 TITLE?

- Disc title entry indication (mode):** appears when you press TITLE when MD deck B stops.

DISC TITLE?

4 Rotate the *right* jog dial to change the title entry mode.

- Title entry mode changes as follows:

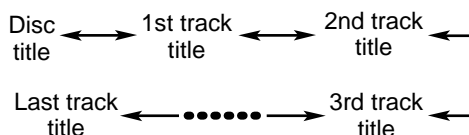

5 Press SET to enter the selected title entry mode.

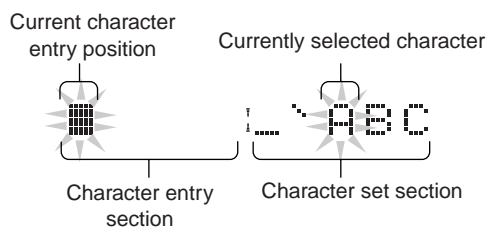

6 Press DISPLAY/CHARA to select the character set you want.

- Each time you press the button, the character sets change as follows:

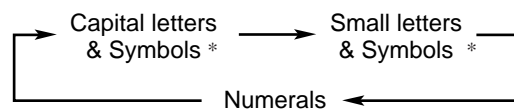

* See page 46 for available symbols.

7 Input a character.

- EX. When entering "H"

1) Rotate the *right* jog dial until "H" is selected.

HFGHIJ

2) Press SET.

The selected character is entered, and the character entry position moves to the next.

H HFGHIJ

- To move the character entry position while entering a title, rotate the *left* jog dial.
- If you have entered an incorrect character, press CANCEL to cancel the last entry.
- To enter a blank, rotate the *left* jog dial to the right without entering any character (or select a blank by rotating the *right* jog dial, then press SET).

8 Repeat steps 6 and 7 to enter other characters.

- The main display can only show 4 characters at a time. If you enter the 5th character, the first character disappears, and so on.

- 9** Press ENTER (START) to finish the current title entry.
 “EDITING” appears for a while, then the unit enters title entry mode again.
- You can assign another title by repeating steps 4 to 9.

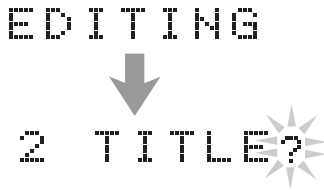

- 10** Press ENTER (START) again to finish the title entry.
- 11** If you have assigned titles while playing the MD, press ■ to stop playing.
- 12** Press ▲ for MD deck B to eject the MD.
 “WRITING” appears while the editing you have made is being recorded on the MD.

WRITING



You can assign titles during play or recording

- During play:**
 - Entering a track title**
 MD deck B repeats playback of the current track until you press ENTER (START) in step 10 above. When you press ENTER (START), the next track will be played.
 - Entering a disc title**
 MD deck B repeats playback of all tracks of the MD until you press ENTER (START) in step 10 above. MD play continues.
- During recording:**
 - Entering a track title**
 MD deck B continues recording even after you press ENTER (START) in step 10 above. When you press ENTER (START), a track title is assigned to the track where you have started the title entry.
- During CD to MD Synchronized Recording (including First Track, Listening Edit, Triple, Long Recordings):**
 You can assign the disc title, and 16 track titles one after another as recording goes on. The track titles you have entered are automatically assigned to the tracks recorded on the MD in sequential order. If you enter 17th track title or more, they are ignored.



During MD to MD Synchronized Recording

You cannot assign titles manually, since the titles already assigned to the source MD are automatically duplicated on the target MD as recording goes on.



Available Symbols are as follows:

(Blank)	!	"	#	\$	%	&	'	()
*	+	,	-	.	/	:	;	< =
>	?	@	_	\				

Changing the Title

You can make a correction or change the title.

- Follow steps 1 to 5 of page 45.
- Rotate the *left* jog dial to select the character you want to correct.
 - Make sure that the character you want to change is flashing.
- Press CANCEL to delete the character you have selected in the above step.
- Input the correct character.
 - Press DISPLAY/CHARA to select the character set you want.
 - Rotate the *right* jog dial to select the correct character, then press SET.
- Repeat steps 2 to 4 of the current procedure to correct more characters.
- Press ENTER (START) to finish correcting the title.
 - If you want to correct another title, select another title entry mode by rotating the *right* jog dial, press SET, then repeat from step 2 above.
 - If you want to finish the correction, go to the next step.
- Press ENTER (START) to finish the title entry.
- If you have assigned titles while playing the MD, press ■ to stop playing.
- Press ▲ for MD deck B to eject the MD.
 “WRITING” appears while the editing you have made is being recorded on the MD.

To erase all the characters

Press CANCEL repeatedly in step 3 above to erase all the characters, then go to step 6.

Assigning a Title Using the Remote Control

In the following example, the process is explained from the very first — that is, inserting a disc. If you already start recording or playing, start from step 3.

- To stop any time during the following process, press MD TITLE INPUT.

1 Insert an MD you want to edit into the MD B loading slot.

2 Press one of the MD number buttons (MD 1, MD 2, and MD 3) corresponding to the MD you want to assign titles.

MD deck B starts playing the MD.

- If you do not have to listen to the MD while assigning titles, press ■ for MD deck B to stop playing.

3 Press MD TITLE INPUT.

MD deck B enters title entry mode.

- Track title entry indication (mode):** appears when you press MD TITLE INPUT while playing or recording.

1 TITLE?

- Disc title entry indication (mode):** appears when you press MD TITLE INPUT when MD deck B stops.

DISC TITLE?

4 Press ← or → to change the title entry mode.

- Title entry mode changes as follows:

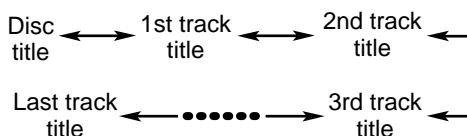

5 Press SET to enter the selected title entry mode.

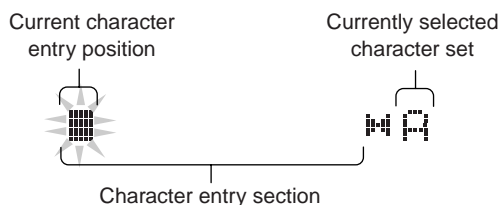

6 Press DISPLAY/CHARA to select the character set you want.

- Each time you press the button, the character sets change as follows:

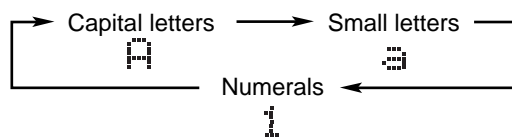

7 Input a character.

1) Press the character entry button for a character you want to input.

Examples:

- To input an “A” or “a,” press ABC once.
- To input a “B” or “b,” press ABC twice.
- To input a “C” or “c,” press ABC three times.
- To input a “D” or “d,” press DEF once.
- To input an “E” or “e,” press DEF twice.
- To input an “F” or “f,” press DEF three times.

.....

- To input a symbol, press MARK repeatedly until the mark you want appears.
- To move the character entry position while entering a title, press ← or →.
- If you have entered an incorrect character, press CANCEL to cancel the last entry.

2) Press the button for the next character you want to input.

- If the next character you want to input is assigned to the same button you have just pressed in step 7-1), press → first to move the character entry position to the right.

8 Repeat steps 6 and 7 to enter other characters.

- The main display can only show 8 characters at a time. If you enter the 9th character, the first character disappears, and so on.

9 Press ENTER to finish the current title entry.

“EDITING” appears for a while, then the unit enters title entry mode again.

EDITING



2 TITLE?

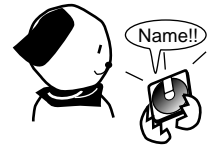

10 Press ENTER again to finish the title entry.

11 If you have assigned titles while playing the MD, press ■ to stop playing.

12 Press ▲ for MD deck B (on the unit) to eject the MD.
“WRITING” appears while the editing you have made is being recorded on the MD.

WRITING



You can assign titles during play or recording

- **During play:**
 - Entering a track title**
MD deck B repeats playback of the current track until you press ENTER in step 10 above. When you press ENTER, the next track will be played.
 - Entering a disc title**
MD deck B repeats playback of all tracks of the MD until you press ENTER in step 10 above. MD play continues.
- **During recording:**
 - Entering a track title**
MD deck B continues recording even after you press ENTER in step 10 above. When you press ENTER, a track title is assigned to the track where you have started the title entry.
- **During CD to MD Synchronized Recording (including First Track, Listening Edit, Triple, Long Recordings):**
You can assign the disc title, and 16 track titles one after another as recording goes on. The track titles you have entered are automatically assigned to the tracks recorded on the MD in sequential order. If you enter 17th track title or more, they are ignored.



During MD to MD Synchronized Recording

You cannot assign titles manually, since the titles already assigned to the source MD are automatically duplicated on the target MD as recording goes on.

Changing the Title

You can make a correction or change the title.

1 Follow steps 1 to 5 of page 47.

2 Press ← or → to select the character you want to correct.

- Make sure that the character you want to change is flashing.

3 Press CANCEL to delete the character you have selected in the above step.

4 Input the correct character by pressing one of the character entry buttons.

5 Repeat steps 2 to 4 of the current procedure to correct more characters.

6 Press ENTER to finish correcting the title.

- If you want to correct another title, select another title entry mode by pressing ← or →, press SET, then repeat from step 2 above.
- If you want to finish the correction, go to the next step.

7 Press ENTER to finish the title entry.

8 If you have assigned titles while playing the MD, press ■ to stop playing.

9 Press ▲ for MD deck B (on the unit) to eject the MD.
“WRITING” appears while the editing you have made is being recorded on the MD.

To erase all the characters

Press CANCEL repeatedly in step 3 above to erase all the characters, then go to step 6.

Using the Timers

The buttons and controls enlarged in the illustration below are used and explained in this section (pages 50 to 52).

Front panel

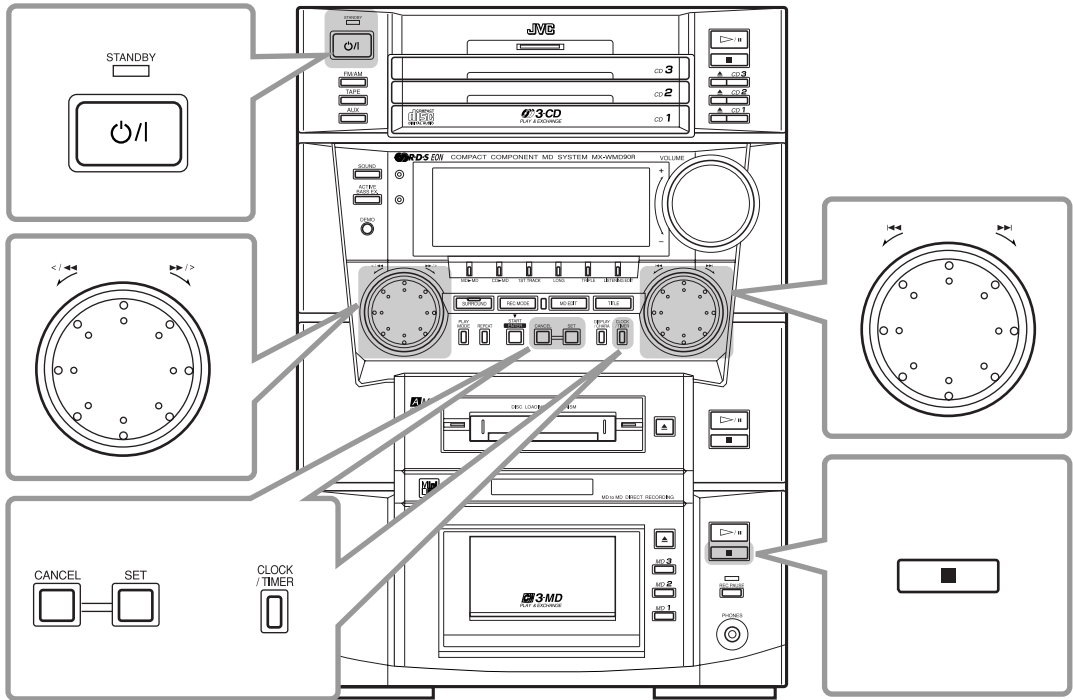

Remote control

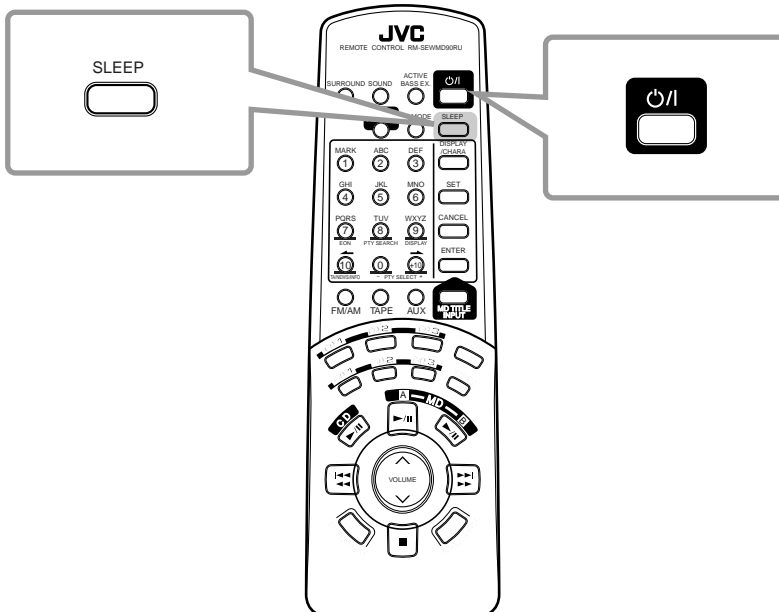

There are three timers available — Recording Timer, Daily Timer, and Sleep Timer.

Before using these timers, you need to set the clock built in the unit. (See page 11.)

Using Recording Timer

With Recording Timer, you can make an MD of a radio broadcast automatically. You can set three Recording Timer separately.

- You can set Recording Timer whether the unit is turned on or off.
- To correct a mis-entry any time during the setting process, press CANCEL.

If the CANCEL button does not work, press CLOCK/TIMER repeatedly and start from step 1 again.

How Recording Timer actually works

The unit automatically turns on, tunes into the specified station, turns off the volume, and starts recording on the MD when the timer-on time comes. Then, when the timer-off time comes, the unit automatically turns off (stands by). Recording Timer works only once, but the timer settings remain stored in memory until you reset them or disconnect the AC power cord.

1 Press CLOCK/TIMER repeatedly to select Timer Recording 1, 2 or 3 setting mode.

- Each time you press the button, the timer mode changes as follows:

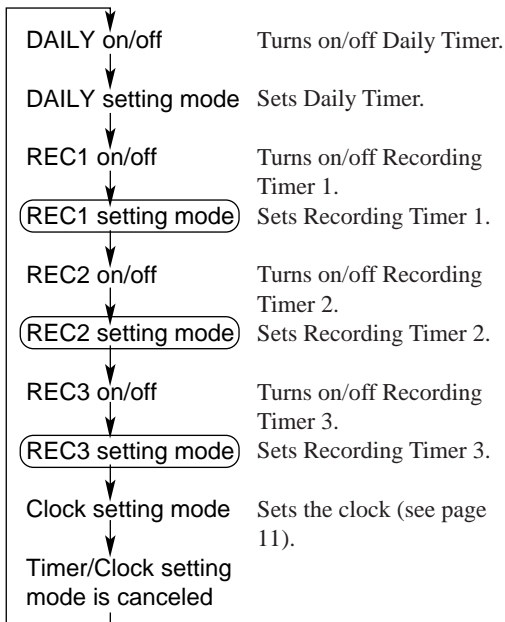

ON



2 Rotate the *right* jog dial to set the hour of the timer-on time, then press SET.

3 Rotate the *right* jog dial to set the minute of the timer-on time, then press SET.

4 Rotate the *right* jog dial to set the hour of the timer-off time, then press SET.

5 Rotate the *right* jog dial to set the minute of the timer-off time, then press SET.

6 Rotate the *right* jog dial to select a preset station channel number, then press SET.

7 Rotate the *right* jog dial to select a recordable MD in deck B, then press SET.

The corresponding REC (1, 2, 3) indicator stops flashing and remains lit. The settings you have done are shown in the main display in sequence.

- You can select “MD 1,” “MD 2,” “MD 3,” and “MD ALL.” When you select “MD ALL,” recording will be done on all loaded MDs continuously.

8 Press  to turn off the unit (on standby) if necessary.

To stop recording any time, press  on MD deck B.



After a timer recording is complete...

Set the volume to an appropriate listening level.

- While recording volume is turned off, and will not be restored automatically.

To turn on or off Recording Timer after its setting is done

- 1 Press CLOCK/TIMER repeatedly until “REC1,” “REC2,” or “REC3,” which you want appears in the main display.
- 2 To turn off the Recording Timer, press CANCEL. The corresponding REC (1, 2, 3) indicator goes off from the display. The Recording Timer is canceled, but the setting for the Recording Timer remains in memory.

To turn on the Recording Timer, press SET.

The corresponding REC (1, 2, 3) indicator lights up on the display. The settings you have done are shown in the main display in sequence for your confirmation.

Using Daily Timer

With Daily Timer, you can wake up to your favorite music or radio program.

- You can set Daily Timer whether the unit is turned on or off.

How Daily Timer actually works

The unit automatically turns on, and starts playing the specified source when the timer-on time comes. Then, when the timer-off time comes, the unit automatically turns off (stands by).

Daily Timer works every day, and the timer settings remain stored in memory until you reset them or disconnect the AC power cord.

1 Press CLOCK/TIMER repeatedly to select Daily Timer setting mode.

- Each time you press the button, the timer mode changes as follows:

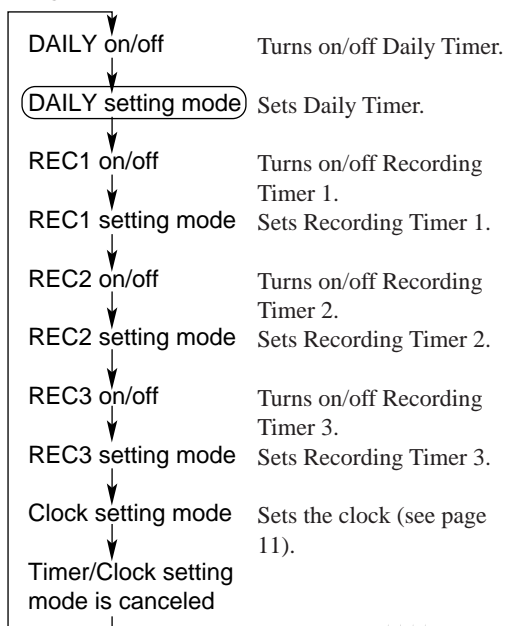

ON



2 Rotate the right jog dial to set the hour of the timer-on time, then press SET.

3 Rotate the right jog dial to set the minute of the timer-on time, then press SET.

4 Rotate the right jog dial to set the hour of the timer-off time, then press SET.

5 Rotate the right jog dial to set the minute of the timer-off time, then press SET.

6 Rotate the right jog dial to set the source, then press SET.

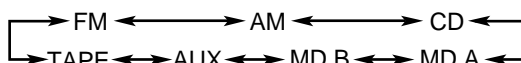

FM: Tunes into the last received FM station.

AM: Tunes into the last received AM (MW/LW) station.

CD: Plays a CD. Prepare a CD, then go to step 7.

MD A: Plays an MD in MD deck A. Prepare an MD.

MD B: Plays an MD in MD deck B. Prepare an MD, then go to step 7.

AUX*: Selects "AUX" as the source. Make the external equipment ready for playback.

TAPE*: Selects "TAPE" as the source. Make the cassette deck ready for playback.

* To operate these equipment with the Daily Timer, they also need to have the timer function.

7 If you have selected CD as the source in the above step, select the CD number.

- Rotate the right jog dial to select the CD number (CD 1 to CD 3).
- Press SET.

If you have selected MD B as the source in the above step, select an MD on MD deck B.

- Rotate the right jog dial to select the MD number (MD 1 to MD 3).
- Press SET.

8 Rotate the right jog dial to set the volume level, then press SET.

The DAILY indicator stops flashing and remains lit. The settings you have done are shown in the main display in sequence.

- You can select the volume level from among 4 settings.

A: Volume level will be set to 5 (low).

B: Volume level will be set to 12 (middle).

C: Volume level will be set to 20 (loud).

—: Volume level will be set the previous level when the unit is turned off.

9 Press $\odot/|$ to turn off the unit (on standby) if you have set the timer with the unit turned on.

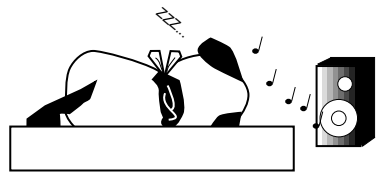

If the unit is kept turned on when the timer-on time comes

Daily Timer does not work at all.



If you press a certain operation button while Daily Timer is operating

Daily Timer is canceled and the unit does not turn off automatically.

To turn on or off Daily Timer after its setting is done

- 1 Press **CLOCK/TIMER** repeatedly until “**DAILY**” appears on the display.
- 2 To turn off the Daily Timer, press **CANCEL**. The DAILY indicator goes off from the display. The Daily Timer is canceled, but the setting for the Daily Timer remains in memory.

To turn on the Daily Timer, press **SET**.

The DAILY indicator lights up on the display. The settings you have done are shown in the main display in sequence for your confirmation.

Using Sleep Timer

With Sleep Timer, you can fall asleep to your favorite music.

You can set Sleep Timer when the unit is turned on.

How Sleep Timer actually works

The unit automatically turns off after the specified time length passes.

On the remote control ONLY:

1 Press **SLEEP**.

- Each time you press the button, the time length changes as follows:

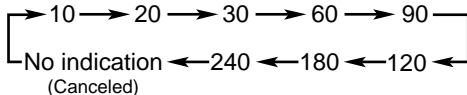

2 Wait for about 5 seconds after specifying the time length.

The display window dims.

To check the remaining time until the shut-off time, press **SLEEP** once. The remaining time until the shut-off time appears for about 5 seconds.

To change the shut-off time, press **SLEEP** repeatedly until the time length you want appears.

To cancel the setting, press **SLEEP** repeatedly until the time indication disappears.

- Turning off the unit also cancels Sleep Timer.

Timer Priority

Since each timer can be set separately, you may wonder what happens if the setting for these timers overlaps. Here are the priorities for each timer.

- **Recording Timer has priority over Daily Timer and Sleep Timer.**

If Daily Timer is set to come on while Recording Timer is operating, Daily Timer will not come on at all.

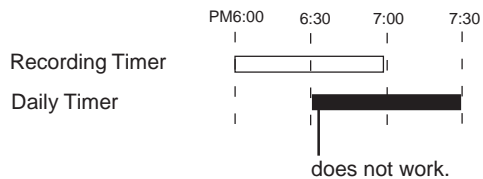

If Recording Timer is set to come on while Sleep Timer is operating, Sleep Timer will be canceled several seconds before Recording Timer comes on.

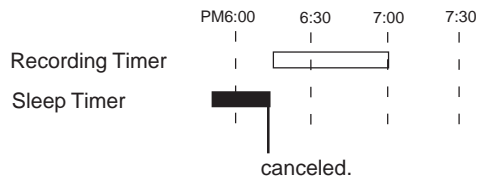

If two Recording Timers overlaps, the one with a late on-time has the priority.

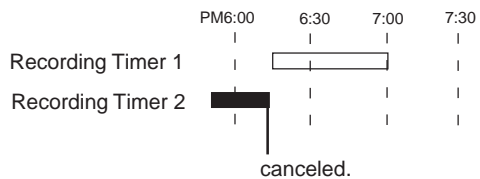

Maintenance

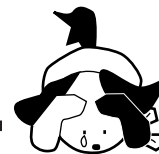

To get the best performance of the unit, keep your discs and mechanism clean.

General Notes

In general, you will have the best performance by keeping your CDs, MDs and the mechanism clean.

- Store CDs and MDs in their cases, and keep them in cabinets or on shelves.
- Keep the CD trays, and the MD loading slot cover closed when not in use.

Handling CDs



- Remove the CD from its case by holding it at the edge while pressing the center hole lightly.
- Do not touch the shiny surface of the disc, or bend the CD.
- Put the CD back in its case after use to prevent warping.

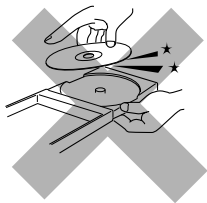

- Be careful not to scratch the surface of the CD when placing it back in its case.
- Avoid exposure to direct sunlight, temperature extremes, and moisture.

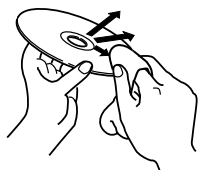

To clean the CD

Wipe the CD with a soft cloth in a straight line from center to edge.

Handling MDs

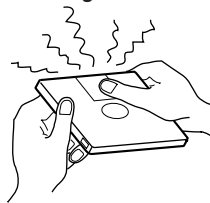

- Do not open the shutter.
 - The shutter is locked so that it will not open. Trying to force it open will break the MD. If the shutter opens accidentally, close it again quickly without touching the MD inside.

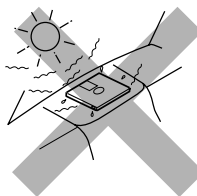

- Do not place MDs in the following places:
 - High temperature areas such as in direct sunlight or inside a car.
 - High humidity areas, e.g. in a bathroom.
 - On a beach or sandy area.

- Clean MDs regularly.
 - If dust or dirt gets on cartridge, wipe it off with a soft dry cloth.



DO NOT use any solvent — such as conventional record cleaner, spray, thinner, or benzine — to clean the CD.

MD Disc Types

There are two types of MDs: Premastered (prerecorded) and Recordable (blank).

Premastered MDs

Premastered MDs, which have been recorded at music studio, can be played back like regular CDs. On an MD of this type, data is recorded as the presence or absence of tiny pits. A laser beam focuses on the pits on the surface of the MD and reflects the detection back to the lens in the MD deck. MD deck then decodes the signals and plays them back as music. This type of MD is called an “optical disc.”

Recordable MDs

Recordable MDs, which use magneto-optical technology, can be recorded and played back repeatedly. The laser inside the MD deck applies heat to the MD, demagnetizing the magnetic layer of the MD for recording and playback. This type of MD is called an “magnetic-optical disc.”

ATRAC (Adaptive TRansform Acoustic Coding)

The MD provides 74 minute recording and playback time, the same as an audio CD, but in a diameter of only 64 mm. This ability to store such a large amount of data is the result of ATRAC, an audio compression technique developed for MD. This technology cuts out faint sounds that would not be heard by the human beings. This technology, based on human sensitivity to sounds, reduces recorded data volume up to about one-fifth of that of the original data.

UTOC (User Table Of Contents)

Found only on recordable MDs, this area contains sub-data (track number, recording data, etc.) which can be rewritten by the user.

UTOC enables us to search tracks quickly and edit tracks on the MD.

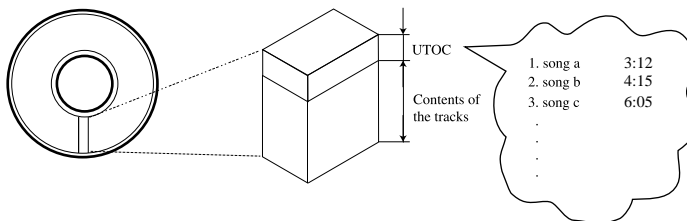

SCMS (Serial Copy Management System)

MD deck integrated to this unit uses the Serial Copy Management System which allows only first-generation digital copies to be made of premastered software (like CDs or prerecorded MDs).

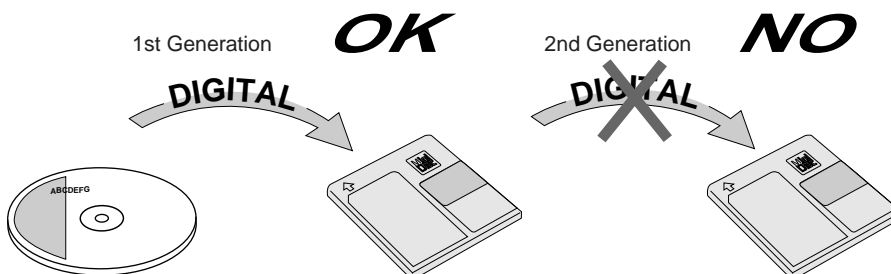



Sound Skip Guard Memory

The biggest weakness of discs is their susceptibility to vibration. The “Sound Skip Guard Memory” has been developed to cope with this weakness.

With this function, a few seconds of signals read by the optical read head from the MD are first stored in memory before being reproduced as audio signals. Thus, even when vibration or shock interrupts signals being read, these stored signals can continue to reproduce sounds for the few seconds. Thus, the user will enjoy uninterrupted music.

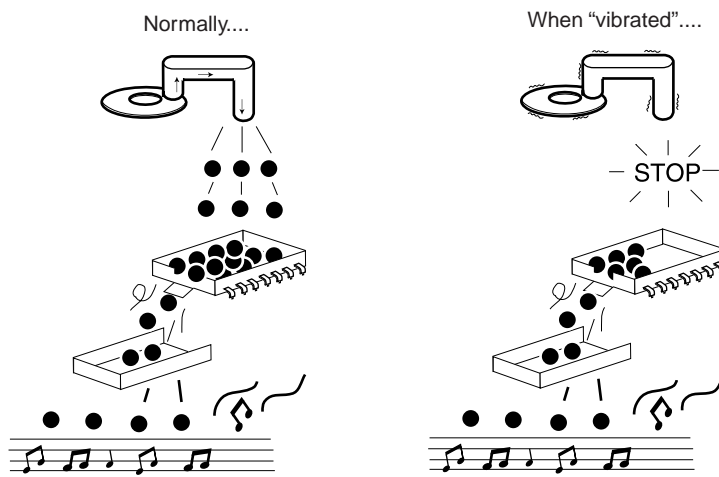

MD limitations	
The MD records data in an original format that differs from that of conventional cassette tapes or DATs. Since there are some limitations with this recording format, the following types of symptoms may occur. These symptoms are not malfunctions.	
Symptoms	Cause
“DISC FULL” appears, even though there is still enough remaining time on an MD.	There is a maximum number of tracks which can be recorded, regardless of recording time. More than 254 tracks cannot be recorded on an MD.
“DISC FULL” appears even though the number of tracks and recording time do not reach the limit.	<ul style="list-style-type: none"> Repeating erasure and recording on the same MD creates many blank portions sparsely on the MD. When recording on such an MD, a track is recorded on these blank portions sparsely. If a track is divided and recorded into so many portions, “DISC FULL” appears. If a divided portion of less than 8 seconds is made while a track is recorded on the MD, that track cannot be joined to another track using the JOIN function. Furthermore, if that track is erased, the remaining time of the MD may not increase exactly by the erased amount. If a track has been divided into many portions while being recorded on the MD, sounds will drop out while fast forwarding or reversing such an MD.
The JOIN function sometimes does not work.	
The remaining time on the MD does not increase even when tracks are erased.	
The sound drops out during fast forward or fast reverse.	
The amount of recorded time on the MD added to the amount of remaining time is shorter than the MD’s total possible recording time.	

If you are having a problem with your unit, check this list for a possible solution before calling for service. If you cannot solve the problem from the hints given here, or the unit has been physically damaged, call a qualified person, such as your dealer, for service.

Symptom	Possible Cause	Action
No sound is heard.	Connections are incorrect, or loose.	Check all connections and make corrections. (See pages 6 – 9.)
Unable to record on an MD.	<ul style="list-style-type: none"> You are using a prerecorded MD. The MD is write-protected. 	<ul style="list-style-type: none"> Change it with a recordable MD. Unprotect the MD. (See page 30.)
Poor radio reception.	<ul style="list-style-type: none"> The antenna is not connected correctly. The AM loop antenna is too close to the unit. The FM antenna is not properly extended and positioned. 	<ul style="list-style-type: none"> Reconnect the antenna securely. Change the position and direction of the AM loop antenna. Extend FM antenna to the best reception position.
The CD skips.	The CD is dirty or scratched.	Clean or replace the CD. (See page 53.)
Unable to operate the remote control.	<ul style="list-style-type: none"> The path between the remote control and the remote sensor on the unit is blocked. The batteries have lost their charge. 	<ul style="list-style-type: none"> Remove the obstruction. Replace the batteries.
The number buttons and CD and MD operation buttons on the remote control do not function correctly.	The operation modes for the unit and for the remote control do not match.	Match them correctly.
Loaded CDs and MD cannot be ejected.	<ul style="list-style-type: none"> The main AC power cord is not plugged in. The Disc Lock function is in use. 	<ul style="list-style-type: none"> Plug in the AC power plug. Turn off the Disc Lock function. (See page 22.)
The CD does not play.	The CD is upside down.	Put the CD in with the label side up.
Operations are disabled.	The built-in microprocessor has malfunctioned due to external electrical interference.	Unplug the unit then plug it back in.



MD Messages

Message	Signification	Solution
BLANK DISC	The disc is blank.	Change the MD with another if you want to enjoy playback.
CANNOT JOIN	You are trying to join tracks which cannot be joined.	This is not a malfunction. (See MD limitations on page 55.)
DISC ERROR	There is a problem with this MD.	Change the MD.
DISC FULL	There is no more space on the MD or there are over 254 tracks.	Use another recordable MD or erase some tracks.
EMERGENCY STOP	A malfunction has occurred during recording.	Eject the MD and re-insert it.
MD NO DISC	There is no MD.	Put an MD.
NON-AUDIO CANNOT COPY	You are trying to copy a non-audio disc like a CD-ROM or a Video CD.	Stop recording.
PLAY BACK	You are trying to edit or record on a playback-only MD.	Use a recordable MD.
DISC PROTECTED	The MD is write-protected.	Unprotect the MD or use another. (See page 30.)
SCMS CANNOT COPY	Digital copy of the 2nd generation is prohibited.	Use an analog recording method.
OCCUPIED	During playback, you have inserted an MD into MD deck B loading slot where another MD had been inserted.	Remove the MD.
LOAD ERROR	MD is not inserted correctly.	Insert the MD correctly.
DIGITAL IN UNLOCK	There is no digital device connected to the AUX DIGITAL IN OPTICAL terminal.	Connect a digital device using digital optical cord.

Specifications



Amplifier

Output Power (IEC 268-3/DIN):

34 watts per channel, min. RMS, both channels driven into 6 ohms at 1 kHz, with no more than 0.9% total harmonic distortion

Audio input sensitivity/Impedance (at 1 kHz)

Analog input:

TAPE: 220 mV/57 kohms

AUX: 520 mV/47 kohms

Digital input:

AUX: Optical

Signal wave length: 660 nm

Input level: -23 dBm to -15 dBm

(With the built-in sampling rate converter, corresponding to 32 kHz/44.1 kHz/48 kHz)

Audio output level/Impedance (at 1 kHz)

TAPE: 160 mV/2.2 kohms

Speakers/Impedance: 6 – 16 ohms

Tuner

FM tuning range: 87.50 — 108.00 MHz

AM (MW/LW) tuning range:

MW: 522 — 1,629 kHz

LW: 144 — 288 kHz

CD player

CD Capacity: 3 CDs

Dynamic range: 92 dB

Signal-to-noise ratio: 100 dB

Wow and flutter: Immeasurable

MD deck

Audio playing system: MiniDisc digital audio system

Recording system: Magneto-optical overwrite system

Reading system: Non-contact, semiconductor laser pickup ($\lambda=780$ nm)

Error correction system: CIRC (Cross Interleave Reed-Solomon Code)

Sampling frequency: 44.1 kHz
(With sampling rate converter for recording — 32 kHz/44.1 kHz/48 kHz)

Audio compression system:

ATRAC (Adaptive TRansform Acoustic Coding)

General

Power requirement: AC 230V \sim , 50 Hz

Power consumption: 110 watts (at operation)
10 watts (on standby)

Dimensions (approx.): 245 x 345 x 368 mm (W/H/D)
(9¹¹/₁₆ x 13⁵/₈ x 14¹/₂ in.)

Mass (approx.): 9.8 kg (21.7 lbs)

Supplied accessories

See page 6.

Design and specifications are subject to change without notice.

US and foreign patents licensed from Dolby Laboratories Licensing Corporation.

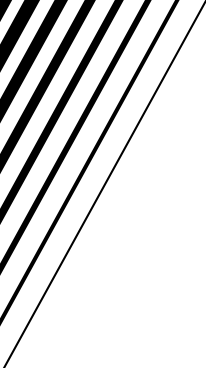

JVC
VICTOR COMPANY OF JAPAN, LIMITED